

2

DIAMANTGEREEDSCHAP EN MACHINES *OUTILS DIAMANTÉS ET MACHINES*

DIAMANTZAGEN
SLIJKOPPEN
TOEBEHOREN VOOR POLIJSTMACHINES
VOEGENFREZEN
DIAMANT BOORKRONEN
TOEBEHOREN VOOR TEGELBOREN &
BOORTECHNIEK
ELEKTRISCHE DIAMANTZAAGMACHINES

*DISQUES DIAMANTÉS
DISQUES À SURFACER
ACCESSOIRES POUR MACHINE À POLIR
FRAISES À DÉJOINTOYER
COURONNES DIAMANTÉES
ACCESSOIRES POUR FORETS SPECIALE
CARRELAGE & TECHNIQUES DE FORAGE
TRONÇONNEUSES DIAMANTÉES
ÉLECTRIQUES*



BATTIPAV™

PRO DIA X O®
WWW.PRODIA XO.COM

PRODIAXO QUICK SEARCH 4-STEP

1

BEPAAL DE MACHINE
DÉTERMINER LA MACHINE



HAAKSE SLIJPER
MEULEUSE



TAFELZAAG
TABLE DE SCIAGE



AFKORTZAAG
SCIE CIRCULAIRE



SCHUURMACHINE
PONCEUSE



TEGELZAAG
COUPE CARRELAGE



DOORSLIJPER
TRONÇONNEUSE



VERSTEKZAAG
SCIE À ONGLET



VLOERZAAG
SCIE DE SOL



SLEUVENZAAG
RAINUREUSE

2

BEPAAL DE DIAMETER EN HET ASGAT
DÉTERMINER LE DIAMÈTRE ET L'ALÉSAGE



3

MET OF ZONDER WATERKOELING
AVEC OU SANS REFOUILLISSEMENT À EAU



NAT GEBRUIK
UTILISATION À EAU



DROOG GEBRUIK
UTILISATION À SEC

4

BEPAAL HET KWALITEITSNIVEAU EN HET TE BEWERKEN MATERIAAL
DÉTERMINER LE NIVEAU DE QUALITÉ ET LE MATERIAU À TRAVAILLER

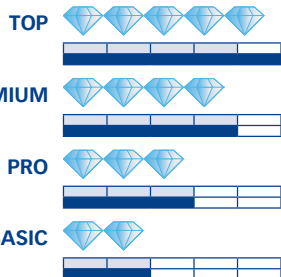

LEVENSDUUR / LONGÉVITÉ
PERFORMANCE

CONSTRUCTION

KLINKERS • BETON • BAKSTEEN
CLINKERS • BÉTON • BRIQUES

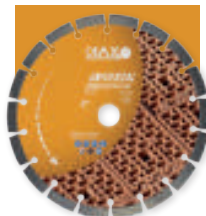

BASIC



PRO



PREMIUM



TOP

CERAMICS

NATUURSTEEN • TEGELS • ARDUIN
PIERRE NATURELLE • CARRELAGES • PIERRE BLEUE



BASIC



PRO



PREMIUM



TOP

SPECIAL

VEZELCEMENTPLATEN • CELLENBETON • ASFALT
PLAQUES CIMENTÉES • BÉTON CELLULAIRE • ASPHALTE



PRO



PREMIUM



INFO

**KARAKTERISTIEKEN
CARACTÉRISTIQUES**



LASERGELAST
SOUDÉS LASER



SPEED CUT



SILENT



LONG LIFE



Organisation for the Safety of Abrasives



CUBIX TECHNOLOGY

Technologie waarbij de verdeling van de diamanten in de segmenten op een gelijkmatige en gestructureerde manier gebeurt. Deze optimale verdeling resulteert in langere levensduur, gelijkmatige slijtage en een snelle snede.



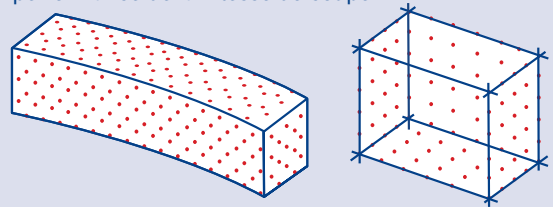



Technologie qui permet à chaque grain de diamant d'être placé de façon structurée dans un segment. Cette structure optimale permet une plus grande longévité ainsi qu'une usure uniforme et une haute performance de la vitesse de coupe.



- 1 Benaming van de schijf
Dénomination du disque
- 2 Kwaliteitsniveau
Niveau de qualité
- 3 OSA logo
- 4 Geschikte machine
Machine adaptée
- 5 Karakteristieken
Caractéristiques
- 6 Afmetingen
Dimensions
- 7 Veiligheidsindicatie
Indications de sécurité
- 8 Bewerkte materiaal
en derivaten
Matériau à travailler
et dérivés













UNIVERSAL
BASIC CONSTRUCTION



Algemene bouwmaterialen, ongewapend beton, klinkers, dakpannen, boordstenen
 Matériaux de construction générale, béton non armé, clinkers, tuiles, bordures

code										min.	€
			mm	mm	mm	mm					
DX 110115		5420000019928	115	22,2	10	2,0	107 gr	-	1	1	8,30
DX 110125		5420000019935	125	22,2	10	2,3	144 gr	-	1	1	9,90
DX 110230		5420000019942	230	22,2	10	2,3	618 gr	-	1	1	24,70
Prijs per 3 st. • Prix par 3 pcs											
DX 110190		5420000074897	125	22,2	10	2,3	400 gr	-	1	1	24,90
Prijs per 3 st. • Prix par 3 pcs											
DX 110298		5420000058859	230	22,2	10	2,3	1920 gr	-	1	1	66,20

UNI TURBO
BASIC CONSTRUCTION

Algemene bouwmaterialen, ongewapend beton, klinkers, dakpannen, boordstenen
 Matériaux de construction générale, béton non armé, clinkers, tuiles, bordures

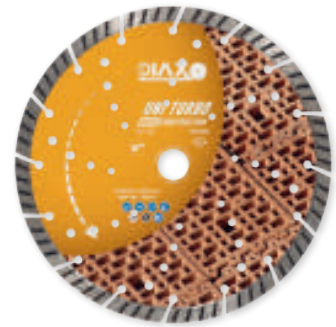
code										min.	€
			mm	mm	mm	mm					
DX 111115		5420000073531	115	22,2	10	2,0	160 gr	-	1	1	8,85
DX 111125		5420000073548	125	22,2	10	2,0	210 gr	-	1	1	9,95
DX 111230		5420000073555	230	22,2	10	2,8	610 gr	-	1	1	28,00
DX 111351		5420000073562	350	25,4	12	3,3	1260 gr	-	1	1	79,00



LASER UNI
PRO CONSTRUCTION



Betonblokken, klinkers, middelharde materialen
Blocs béton, klinkers, matériaux demi-durs

code			mm	mm	mm	mm			min.	€	
DX 112301		5420000019959	300	25,4	10	3,0	1246 gr	-	1	1	90,30
DX 112351		5420000019966	350	25,4	10	3,2	1773 gr	-	1	1	108,00
DX 112401		5420000027084	400	25,4	10	3,6	2250 gr	-	1	1	138,00



LASER BETON
PRO CONSTRUCTION

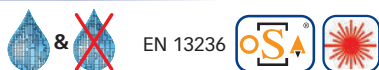

Beton, gewapend beton, klinkers, boordstenen
Béton, béton armé, klinkers, bordures



code			mm	mm	mm	mm			min.	€	
DX 250115		5420000019973	115	22,2	10	2,2	128 gr	-	1	1	20,00
DX 250125		5420000019980	125	22,2	10	2,2	150 gr	-	1	1	21,30
DX 250128		5420000064911	125	X-LOCK / 22,2	10	2,2	160 gr	-	1	1	22,30
DX 250140		5420000025387	140	22,2	10	2,4	200 gr	-	1	1	32,80
DX 250150		5420000022331	150	22,2	10	2,4	225 gr	-	1	1	35,20
DX 250230		5420000019997	230	22,2	10	2,6	604 gr	-	1	1	45,90
DX 250301		5420000020009	300	25,4	10	3,0	1226 gr	-	1	1	93,00
DX 250350		5420000024939	350	20,0	10	3,2	1793 gr	-	1	1	115,00
DX 250351		5420000020016	350	25,4	10	3,2	1804 gr	-	1	1	115,00
DX 250400		5420000069794	400	20,0	10	3,2	2250 gr	-	1	1	149,00
DX 250401		5420000023505	400	25,4	10	3,2	2250 gr	-	1	1	149,00
DX 250451*	vrac	5420000024557	450	25,4	10	3,6	3815 gr	-	1	1	203,00
DX 250501*	vrac	5420000024243	500	25,4	10	3,6	4625 gr	-	1	1	249,00
DX 250601*	vrac	5420000024564	600	25,4	10	4,0	7900 gr	-	1	1	300,00
DX 250298		5420000058873	230	22,2	10	2,6	1950 gr	-	1	1	103,00

Prijs per 3 st. • Prix par 3 pcs

* niet bedrukt / non imprimé

BATTERY BLADE SILENT CORE













PRO CONSTRUCTION



EN 13236

FOR BATTERY MACHINES

 Algemene bouwmaterialen, beton, gewapend beton, natuursteen
 Matériaux de construction générale, béton, béton armé, pierre naturelle

code										min.	€
			mm	mm	mm	mm					
DX 225125		542000068674	125	22,2	10	2	150 gr	-	1	1	28,00
DX 225230		542000068681	230	22,2	10	2,2	480 gr	-	1	1	55,00
DX 225301		542000068698	300	25,4	10	2,6	1000 gr	-	1	1	94,00
DX 225351		542000068704	350	25,4	10	2,8	1480 gr	-	1	1	115,00





















PERFORMER

PRO CONSTRUCTION



EN 13236

 Algemene bouwmaterialen, beton, klinkers, dakpannen, boordstenen
 Matériaux de construction générale, béton, clinkers, tuiles, bordures

code										min.	€
			mm	mm	mm	mm					
DX 440115		542000018747	115	22,2	10	1,8	160 gr	-	1	1	26,80
DX 440125		542000018754	125	22,2	10	2,1	199 gr	-	1	1	29,80
DX 441126		542000064928	125	X-LOCK / 22,2	10	2,2	199 gr	-	1	1	32,90
DX 440150		542000023499	150	22,2	10	2,4	234 gr	-	1	1	46,20
DX 440180		542000024328	180	22,2	10	2,5	376 gr	-	1	1	52,50
DX 440230		542000018761	230	22,2	10	2,8	713 gr	-	1	1	64,00
DX 440301		542000070608	300	25,4	10	3,0	1110 gr	-	1	1	109,00
DX 440350		542000070646	350	20,0	10	3,0	1510 gr	-	1	1	129,00
DX 440351		542000070615	350	25,4	10	3,0	1510 gr	-	1	1	129,00
DX 440400		542000070653	400	20,0	10	3,2	1910 gr	-	1	1	159,00
DX 440401		542000070622	400	25,4	10	3,2	1910 gr	-	1	1	159,00

X-LOCK
PERFORMER

PRO CONSTRUCTION



EN 13236

 Algemene bouwmaterialen, beton, klinkers, dakpannen, boordstenen
 Matériaux de construction générale, béton, clinkers, tuiles, bordures

code										min.	€
			mm	mm	mm	mm					
DX 440127		542000067172	125	M14	10	2,2	182 gr	-	1	1	35,90
DX 440237		542000070158	230	M14	10	2,4	713 gr	-	1	1	72,00

M14

Aansluiting M14 Raccordement

WAVED TURBO

PRO CONSTRUCTION



EN 13236



Baksteen middelhard, proton, vezelcementplaten
Briques demi-durs, proton, plaques cimentées

code										min.	€
			mm	mm	mm	mm					
DX 430125		5420000020412	125	22,2	7	2,2	139 gr	-	1	1	24,40
DX 430230		5420000020429	230	22,2	8	2,8	656 gr	-	1	1	65,50



MULTI-TASK

PREMIUM CONSTRUCTION



Rioolbuizen in PVC / PE / PU / PRV
Canalisations en PVC / PE / PU / PRV



code								min.	€
			mm	mm					
DX 215125		5420000033849	125	22,2	348 gr	-	1	1	76,30
DX 216126		5420000075610	125	22,2	324 gr	-	1	1	82,00



DX 215125



15 mm

NEW



DX 216126

11 mm



Snijden en afschuiven in één enkele handeling
Coupe et chanfreine en une seule opération
Veilig afschuiven
Chanfreinage sécurisé
Zeer lange levensduur
Très longue durée de vie

1
Carbide diamanten op de snij- en afschuivingsvlakken
Diamants électrodéposés sur les sections de coupe et de chanfreinage

2
Verzorgde en gelijkmatige afschuiving (afschuiningsgeleider)
Chanfrein net et régulier (guide de chanfreinage)

Extra vlak / ERC 350 compatibel (blz. 33)
Extra plat / ERC 350 compatible (p. 33)

LASER UNI TURBO

PRO CONSTRUCTION



EN 13236



Betonblokken, klinkers, middelharde materialen
Blocs béton, clinkers, matériaux demi-durs



code										min.	€
			mm	mm	mm	mm					
DX 115501	vrac	5420000066205	500	25,4	10	3,6	4200 gr	-	1	1	169,00
DX 115601	vrac	5420000066212	600	25,4	10	4,0	7300 gr	-	1	1	275,00
DX 115651	vrac	5420000070455	650	25,4	10	4,8	8510 gr	-	1	1	350,00
DX 115701	vrac	5420000066229	700	25,4	10	4,8	10100 gr	-	1	1	387,00

CUBIX MASTER BETON
 PREMIUM CONSTRUCTION

EN 13236



Betonblokken, gewapend beton, harde tot zeer harde materialen
Blocs béton, béton armé, matériaux durs
DX 252706 :
2 EXTRA ZIJGATEN 13 mm !
2 TROUS EXTRA 13 mm !

code			mm	mm	mm	mm			min.	€	
DX 252125		5420000071582	125	22,2	10	2,2	230 gr	-	1	1	32,20
DX 252230		5420000071599	230	22,2	10	2,4	610 gr	-	1	1	79,90
DX 252350		5420000070363	350	20,0	10	3,2	1890 gr	-	1	1	149,00
DX 252351		5420000070370	350	25,4	10	3,2	1890 gr	-	1	1	149,00
DX 252400		5420000070387	400	20,0	10	3,2	2440 gr	-	1	1	185,00
DX 252401		5420000070394	400	25,4	10	3,2	2440 gr	-	1	1	185,00
DX 252451*	vrac	5420000070400	450	25,4	10	3,6	3570 gr	-	1	1	223,00
DX 252501*	vrac	5420000070417	500	25,4	10	3,6	4370 gr	-	1	1	314,00
DX 252601*	vrac	5420000070424	600	25,4	10	4,0	7090 gr	-	1	1	374,00
DX 252651*	vrac	5420000070431	650	25,4	10	4,4	9340 gr	-	1	1	495,00
DX 252706*	vrac	5420000070448	700	60,0/55,0	10	4,4	10760 gr	-	1	1	637,00

* niet bedrukt / non imprimé

POWER N

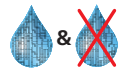
PREMIUM CONSTRUCTION



EN 13236



TOP!
Beton, gewapend beton, harde klinkers, boordstenen
Béton, béton armé, clinkers durs, bordures

code			mm	mm	mm	mm			min.	€	
DX 290115		5420000020269	115	22,2	10	2,6	137 gr	-	1	1	32,00
DX 290125		5420000020276	125	22,2	10	2,6	160 gr	-	1	1	34,00
DX 291126		5420000064959	125	X-LOCK / 22,2	10	2,4	160 gr	-	1	1	39,50
DX 290230		5420000020283	230	22,2	10	2,8	589 gr	-	1	1	89,00
DX 290301		5420000024113	300	25,4	10	3,0	1303 gr	-	1	1	125,00
DX 290350		5420000064119	350	20,0	10	3,0	1800 gr	-	1	1	149,00
DX 290351		5420000024120	350	25,4	10	3,0	1825 gr	-	1	1	149,00
DX 290400		5420000065420	400	20,0	10	3,0	2250 gr	-	1	1	169,00
DX 290401		5420000032569	400	25,4	10	3,0	2250 gr	-	1	1	169,00

XLOCK

POWER XTM

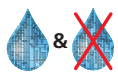
TOP CONSTRUCTION



EN 13236



SUPERFAST TOP!



**Beton, gewapend beton, harde klinkers, boordstenen
Béton, béton armé, clinkers durs, bordures**



code									min.	€	
		mm	mm	mm	mm						
DX 297125		5420000068971	125	22,2	12	2,4	160 gr	-	1	1	42,00
DX 297150		5420000070165	150	22,2	12	2,6	196 gr	-	1	1	45,00
DX 297180		5420000070172	180	22,2	12	2,6	230 gr	-	1	1	58,00
DX 297230		5420000068988	230	22,2	12	2,6	700 gr	-	1	1	96,00
DX 297301		5420000068995	300	25,4	12	2,8	1200 gr	-	1	1	139,00
DX 297350		5420000069008	350	20,0	12	3,2	1800 gr	-	1	1	169,00
DX 297351		5420000069015	350	25,4	12	3,2	1800 gr	-	1	1	169,00
DX 297400		5420000072138	400	20,0	12	3,2	2400 gr	-	1	1	201,00
DX 297401		5420000069022	400	25,4	12	3,2	2400 gr	-	1	1	201,00



BLADE RUNNER

TOP CONSTRUCTION

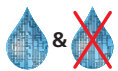

EN 13236



TOP!

**Grindtegels, beton, sterk gewapend beton, kandla
Dalles gravillonnées, béton, béton fortement armé, kandla**



code									min.	€	
		mm	mm	mm	mm						
DX 275230		5420000020207	230	22,2	12	2,7	580 gr	-	1	1	109,00
DX 275350		5420000023987	350	20,0	12	2,8	1676 gr	-	1	1	169,00
DX 275351		5420000020221	350	25,4	12	2,8	1671 gr	-	1	1	169,00
DX 275400		5420000023994	400	20,0	12	3,2	2497 gr	-	1	1	189,00
DX 275401		5420000023482	400	25,4	12	3,2	2476 gr	-	1	1	189,00





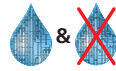









**"Kandla": platte (± 4-5 cm) natuurlijke zandsteen
"Kandla": grès naturel, plat (± 4-5 cm)**

TURBO ABRASIV
PRO CONSTRUCTION

EN 13236













Baksteen zacht, asfalt, gasbeton, abrasieve materialen
Briques tendres, asphalte, béton cellulaire, matériaux abrasifs

code										min.	€
			mm	mm	mm	mm					
DX 425125		5420000020375	125	22,2	7	2,2	138 gr	-	1	1	24,40
DX 425150		5420000020382	150	22,2	7	2,2	195 gr	-	1	1	33,30
DX 425230		5420000020399	230	22,2	9	2,8	655 gr	-	1	1	61,90

RESCUE
PREMIUM CONSTRUCTION

EN 13236

Alle steensoorten (behalve abrasieve materialen), metalen, gietijzer, hout, glas ...
Tous les matériaux (sauf matériaux abrasifs), métaux, fonte, bois, verres ...

code										min.	€
			mm	mm	mm	mm					
DX 375125		5420000043299	125	22,2	8	2,8	400 gr	-	1	1	49,10
DX 375230		5420000020351	230	22,2	8	2,7	572 gr	-	1	1	149,00













"MULTI USE"

Multifunctioneel blad "allrounder" speciaal ontwikkeld voor urgentieinterventies
Alle steensoorten (behalve abrasieve materialen) - kunststoffen - metalen - hout - rubber - glas
Disque polyvalent pour application variée pour toutes les interventions d'urgence
Coupe tous les matériaux (sauf matériaux abrasifs) : pierre artificielle et naturelle - métaux - plastique - bois - caoutchoucs - verres

C-FIBER-TURBO
PREMIUM CONSTRUCTION

EN 13236

Sidings, vezelcementplaten, tegels
Sidings, plaques cimentées, carrelages
VOOR VEZELCEMENT
POUR FIBRE-CIMENT

code										min.	€
			mm	mm	mm	mm					
DX 602125		5420000028975	125	22,2	7	1,4	100 gr	-	1	1	37,00
DX 602202		5420000028982	200	30,0	7	1,8	366 gr	-	1	1	63,60
DX 602232		5420000028999	230	30,0	7	1,8	449 gr	-	1	1	69,90

LASER SOFT-BETON

PREMIUM CONSTRUCTION



EN 13236



NEW

Verse beton (voor uitzettingsvoegen) • Béton frais (pour joints de dilatation)

code									min.	€	
		mm	mm	mm	mm						
DX 263303		5420000075559	300	25,4/20,0	10	2,8	1200 gr	-	1	1	135,00
DX 263353		5420000075566	350	25,4/20,0	10	3,2	1400 gr	-	1	1	160,00



Reduceerring 25,4 > 20,0mm
Bague de réduction 25,4 > 20,0mm

MASTER COMBI BETON/ASPHALT

PREMIUM CONSTRUCTION



EN 13236



TOP!

Beton & asfalt • Béton & asphalte

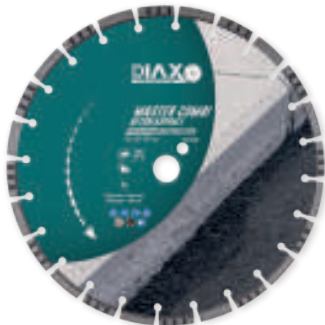

code									min.	€	
		mm	mm	mm	mm						
DX 268350		5420000070356	350	20,0	15	3,2	1920 gr	-	1	1	115,00
DX 268351		5420000022386	350	25,4	15	3,2	1910 gr	-	1	1	115,00
DX 268401		5420000022393	400	25,4	15	3,6	2590 gr	-	1	1	129,00

MASTER ASPHALT

PREMIUM CONSTRUCTION



EN 13236



TOP!

Asfalt • Asphalte





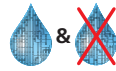





code									min.	€	
		mm	mm	mm	mm						
DX 261351		5420000020139	350	25,4	12	3,2	1707 gr	-	1	1	147,00
DX 261401		5420000020146	400	25,4	12	3,5	2663 gr	-	1	1	189,00



PANTHER
PREMIUM GRANITE / CONSTRUCTION

EN 13236

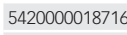
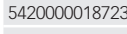
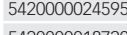

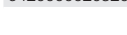

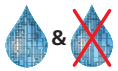





Harde tegels, marmer, graniet, dakpannen, bouwmaterialen, beton
Carrelages durs, marbre, granite, tuiles, matériaux de construction, béton

code								
		mm	mm	mm	mm			
DX 330115	 5420000018716	115	22,2	10	2,2	170 gr	- 1 1	33,30
DX 330125	 5420000018723	125	22,2	10	2,2	195 gr	- 1 1	37,50
DX 330180	 5420000024595	180	22,2	10	3,0	399 gr	- 1 1	48,60
DX 330230	 5420000018730	230	22,2	12	3,0	725 gr	- 1 1	79,00
DX 330301	 5420000020306	300	25,4	10	3,0	1316 gr	- 1 1	149,00
DX 330351	 5420000020320	350	25,4	10	3,5	2013 gr	- 1 1	185,00

COBRA
PREMIUM GRANITE

EN 13236

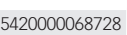
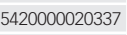
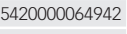
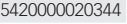
Harde tegels, marmer, graniet
Carrelages durs, marbre, granite

code								
		mm	mm	mm	mm			
DX 345115	 5420000068728	115	22,2	10	2,5	125 gr	- 1 1	31,50
DX 345125	 5420000020337	125	22,2	10	2,5	160 gr	- 1 1	45,20
DX 346126	 5420000064942	125	X-LOCK / 22,2	10	2,5	160 gr	- 1 1	47,90
DX 345230	 5420000020344	230	22,2	12	2,8	632 gr	- 1 1	95,20

X-LOCK

RIM

BASIC CERAMICS



EN 13236



Keramische wandtegels • Carrelages murales en céramiques

code			mm	mm	mm	mm			min.	€
DX 507115		5420000020436	115	22,2	6	2,2	117 gr	-	1 1	10,70
DX 507125		5420000020443	125	22,2	6	2,2	135 gr	-	1 1	13,70



DOLPHIN RIM

PRO CERAMICS



Ø 115 / Ø 125 mm



Ø 180 → Ø 350 mm

EN 13236



Keramische tegels (+ hard) • Carrelages céramiques (+ durs)



code			mm	mm	mm	mm			min.	€
DX 550115		5420000018778	115	22,2	7	1,4	116 gr	-	1 1	17,80
DX 550125		5420000018785	125	22,2	7	1,4	137 gr	-	1 1	19,70
DX 550181		5420000020450	180	25,4	7	1,6	282 gr	-	1 1	34,50
DX 550201		5420000020467	200	25,4	7	1,6	364 gr	-	1 1	36,50
DX 550231		5420000020474	230	25,4	7	1,6	453 gr	-	1 1	48,00
DX 550251		5420000020481	250	25,4	7	1,6	562 gr	-	1 1	68,00
DX 550302		5420000020498	300	30/25,4	7	2,0	1010 gr	-	1 1	115,00
DX 550352		5420000020504	350	30/25,4	7	2,0	1356 gr	-	1 1	142,00
DX 550190		5420000074910	125	22,2	7	1,4	400 gr	-	3 1	50,50

Prijns per 3 st. • Prix par 3 pcs

OCTOPUS T TURBO

PREMIUM CERAMICS



Ø 115 / Ø 125 mm



Ø 180 → Ø 230 mm

EN 13236



Gres tegels • Carrelages grès

code			mm	mm	mm	mm			min.	€
DX 600115		5420000018792	115	22,2	7	1,4	108 gr	-	1 1	22,00
DX 600125		5420000018808	125	22,2	7	1,4	120 gr	-	1 1	23,80
DX 601181		5420000030091	180	25,4	7	1,4	340 gr	-	1 1	47,60
DX 601201		5420000030107	200	25,4	7	1,6	446 gr	-	1 1	57,10
DX 601230		5420000030114	230	22,2	7	1,6	530 gr	-	1 1	60,10
DX 601231		5420000030121	230	25,4	7	1,6	530 gr	-	1 1	60,10



PRECISION THIN RIM

PREMIUM CERAMICS



EN 13236



Gres tegels • Carrelages grès



code			mm	mm	mm	mm			min.	€
DX 661125		5420000037366	125	22,2	5	1,2	120 gr	-	1 1	22,30
DX 662126		5420000064966	125	X-LOCK / 22,2	5	1,2	120 gr	-	1 1	26,90

VIPER

TOP CERAMICS



EN 13236



TOP!

Gres tegels • Carrelages grès



code								min.	€
		mm	mm	mm	mm				
DX 675115	5420000024137	115	22,2	10	1,4	106 gr	-	1 1	26,00
DX 675125	5420000024144	125	22,2	10	1,4	130 gr	-	1 1	28,20
DX 676126	5420000065727	125	X-LOCK / 22,2	10	1,4	130 gr	-	1 1	34,00
Prijs per 3 st. • Prix par 3 pcs									
● DX 675190	5420000074903	125	22,2	10	1,4	400 gr	-	1 1	73,20

TYCAN

TOP GRES



EN 13236



EXTRA FINE!

TOP!

Gres, harde tegels, graniet, porselein • Grès, carreaux durs, granite, porcelaine

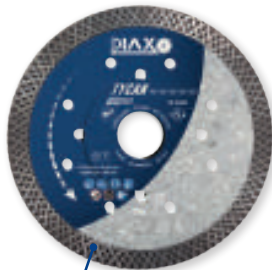

code								min.	€
		mm	mm	mm	mm				
DX 678115	5420000067783	115	22,2	10,5	1,3	125 gr	-	1 1	32,00
DX 678125	5420000067790	125	22,2	10,5	1,3	140 gr	-	1 1	36,00

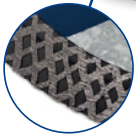

BOA PRECISION TURBO

TOP GRES

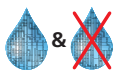

EN 13236



TOP!

NEW

Ø 76 mm

Asgat
Alésage
Ø 10 mm



Ø 125 mm

Gres tegels • Carrelages grès

code								min.	€
		mm	mm	mm	mm				
● DX 679176	5420000075948	76	10,0	7	1,3	100 gr	-	1 1	20,30
DX 679125	5420000049192	125	22,2	10	1,4	125 gr	-	1 1	38,00

PYTHON

TOP GRES



EN 13236

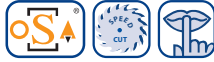

Gres tegels • Carrelages grès

XLOCK

code	Barcode	mm	mm	mm	mm	mm	mm	mm	mm	min.	€
DX 680126	5420000064935	125	X-LOCK / 22,2	10	1,4	125 gr	-	1	1		36,00



MAMBA

PREMIUM GRANITE



EN 13236



Graniet, natuursteen, keramiek, porselein
Granite, pierre naturelle, céramique, porcelaine

1,6!
mm

code	Barcode	mm	mm	mm	mm	mm	mm	mm	mm	min.	€
DX 671115	5420000070325	115	22,2	25	1,6	174 gr	-	1	1		45,00
DX 672000	5420000067806	125	22,2	25	1,6	210 gr	-	1	1		52,80

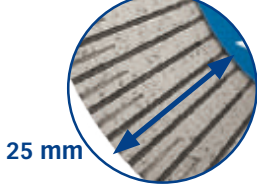

25 mm

Afkanten & polijsten
Biseauter & polisage

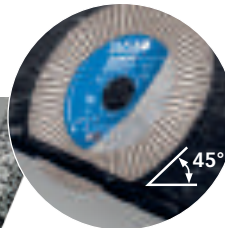

45°

ADVANCED TECHNOLOGY

Duo - Disc

PREMIUM GRANITE/CONSTRUCTION



EN 13236



Natuursteen • Pierre naturelle

Snijden en polijsten
Couper et polir

code	Barcode	mm	mm	mm	mm	mm	mm	mm	mm	min.	€
DX 700125	5420000018877	125	M14	2,7	266 gr	-	1	1			76,00

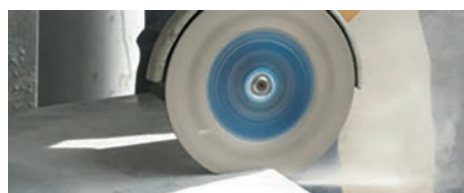

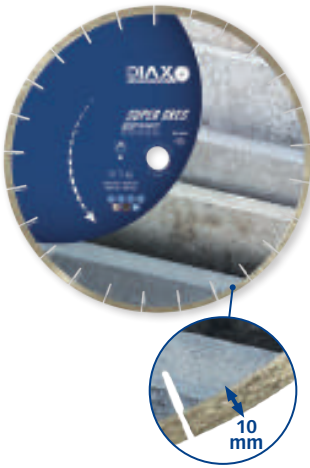













SUPER GRES
 TOP CERAMICS

EN 13236



Hardste keramische tegels, gres tegels, natuursteen (met een dikte tot 40 mm) en graniet
 Céramique, grès durs, pierre naturelle (jusqu'à 40 mm d'épaisseur) et granite

code										min.	€
			mm	mm	mm	mm					
DX 635181		5420000062610	180	25,4	10	2,4	408 gr	-	1	1	76,30
DX 635201		5420000062627	200	25,4	10	2,4	472 gr	-	1	1	88,50
DX 635231		5420000047440	230	25,4	10	2,4	658 gr	-	1	1	95,20
DX 635251		5420000047457	250	25,4	10	2,4	812 gr	-	1	1	138,00
DX 635301		5420000047464	300	30,0/25,4	10	2,6	1300 gr	-	1	1	196,00
DX 635351		5420000047471	350	30,0/25,4	10	2,8	1906 gr	-	1	1	217,00

"Sandwich" Core



Low Noise / Silent

MARMOR













TOP CERAMICS



EN 13236



Marmar, keramische tegels, gres tegels
 Marbre, carrelage en céramique et en grès

code										min.	€
			mm	mm	mm	mm					
DX 681180		5420000043305	180	22,2	7	1,7	380 gr	-	1	1	46,60
DX 681231		5420000029750	230	25,4	7	1,7	413 gr	-	1	1	68,70
DX 681251		5420000029767	250	25,4	7	1,7	576 gr	-	1	1	86,50
DX 681351		5420000020542	350	25,4	7	2,0	1369 gr	-	1	1	210,00





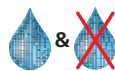







MARMOR

PRO CERAMICS









Marmar • Marbre



code										min.	€
			mm	mm	mm	mm					
DX 683125		5420000029729	125	22,2	3,2	2,2	117 gr	-	1	1	26,70
DX 683231		5420000029736	230	25,4	2,9	2,5	634 gr	-	1	1	55,80
DX 683351		5420000029743	350	25,4	4,0	3,2	1546 gr	-	1	1	114,00

TOEBEHOREN VOOR DIAMANTSCHIJVEN ACCESSOIRES POUR DISQUES DIAMANTÉS





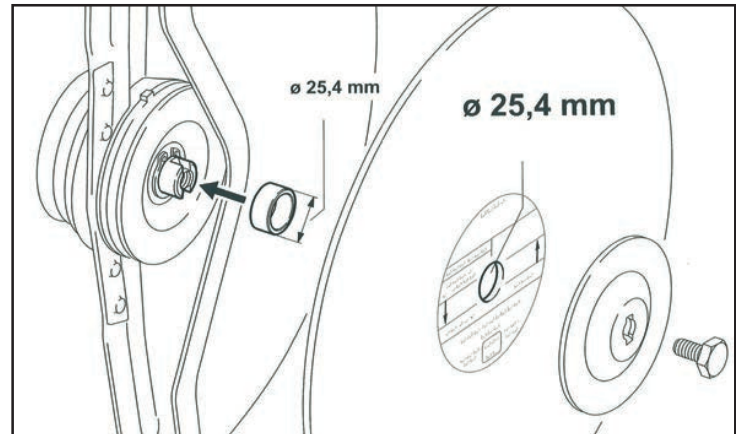

Reduceerring • Bague de réduction

code							min.	€
			mm	mm	mm			
DX 960029	vrac	5420000033979	30,0 >	20,0	2,0	6 gr	- 1 1	7,55
DX 960041	vrac	5420000034075	30,0 >	25,4	1,4	2 gr	- 1 1	7,55
DX 960030	vrac	5420000033986	30,0 >	25,4	2,0	3 gr	- 1 1	7,55
DX 960037	vrac	5420000034051	25,4 >	15,0	1,8	5 gr	- 1 1	5,87
DX 960042	vrac	5420000034082	25,4 >	20,0	1,4	2 gr	- 1 1	5,87
DX 960032	vrac	5420000034006	25,4 >	20,0	2,0	3 gr	- 1 1	5,87
DX 960033	vrac	5420000034013	25,4 >	20,0	3,2	5 gr	- 1 1	5,62
DX 960034	vrac	5420000034020	25,4 >	22,2	1,4	1 gr	- 1 1	5,87
DX 960031	vrac	5420000033993	25,4 >	22,2	1,6	1 gr	- 1 1	5,99
SPECIAL STIHL®								
DX 960043	vrac	5420000034099	25,4 >	20,0	10	14 gr	- 1 1	12,20



Slijpsteen • Pierre d'affutage



code							min.	€
			mm					
EE 35910	vrac	4026851006738	200 x 100 x 50	1705 gr	-	1 1	23,70	

Blauwe prijs • Prix bleu

GC - HARD

PREMIUM CONSTRUCTION



EN 13236

Harde materialen, beton • Matériaux durs, béton

code										min.	€
			mm	mm	mm	mm					
DX 731125		5420000046481	125	22,2	8,0	4,5	480 gr	-	1	1	88,00
DX 731150		5420000070189	150	22,2	8,0	4,5	537 gr	-	1	1	98,00
DX 731180		5420000070196	180	22,2	8,0	4,5	762 gr	-	1	1	119,00

GC - SOFT

PREMIUM CONSTRUCTION



EN 13236

Abrasieve materialen (verse beton) • Matériaux abrasifs (béton frais)

code										min.	€
			mm	mm	mm	mm					
DX 732125		5420000020603	125	22,2	8,3	4,9	472 gr	-	1	1	75,90

TURBO GC-HARD

PREMIUM CONSTRUCTION



EN 13236

Harde beton • Béton dur

code										min.	€
			mm	mm	mm	mm					
DX 733125		5420000024090	125	22,2	8,5	4,5	454 gr	-	1	1	69,30
DX 733180		5420000024106	180	22,2	8,5	4,5	1097 gr	-	1	1	108,00

DIATOP PLUS
TOP CONSTRUCTION



EN 13236



Agressieve vertanding
Denture plus agressive

Harde beton • Béton dur

code							min.	€
DX 734125		5420000043282	mm 125	mm 22,2	360 gr	-	1 1	81,50

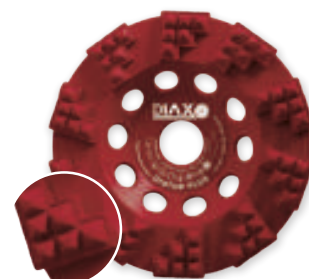

EPOXY
PREMIUM CONSTRUCTION



EN 13236



NEW

Epoxycoatings • Revêtements époxy

code							min.	€
DX 738000		5420000074118	mm 125	mm 22,2	480 gr	-	1 1	79,00



ANTI-DUST PROTECTION

VOOR SNIJSCHIJVEN • POUR DISQUES DE COUPE



MULTI ADAPTOR

MAKITA® / BOSCH® / DEWALT®
MILWAUKEE® / METABO® / HIKOKI® / FLEX®



ADP125K

new design

DX ADP125K



ADP230K



DX ADP230K



new design

MULTI ADAPTOR

MAKITA® / BOSCH® / DEWALT®
MILWAUKEE® / METABO® / HIKOKI® / FLEX®

Stofbeschermkap voor snijschijven
Capot anti-poussière pour disques de coupe

code						min.	€
DX ADP125K	5420000071551	ADP125K	115-125	1000 gr	-	10	106,00
DX ADP230K	5420000071568	ADP230K	180-230	2900 gr	-	4	179,00

machine en schijf niet inbegrepen / machine et disque non incluse

ANTI-DUST PROTECTION

VOOR SLIJPKOPPEN • POUR DISQUES À SURFACER



ADC125G

new design

MULTI ADAPTOR

MAKITA® / BOSCH® / DEWALT®
MILWAUKEE® / METABO® / HIKOKI® / FLEX®



ADC180G

new design

MULTI ADAPTOR

MAKITA® / BOSCH® / DEWALT®
MILWAUKEE® / METABO® / HIKOKI® / FLEX®



Stofbeschermkap voor slijpkoppen
Capot anti-poussière pour disques à surfacer

code								min.	€
				mm					
DX ADC125G		5420000071537	ADC125G	100-125	930 gr	-	10	1	104,00
DX ADC180G		5420000071544	ADC180G	175-180	1240 gr	-	10	1	139,00
Vervangborstel set voor stofbeschermkap • Set de brosse de rechange									
DX ADZB125	polybag	5420000071636	ADC125G	-	350 gr	-	-	1	11,94
DX ADZB180	polybag	5420000071643	ADC180G	-	500 gr	-	-	1	12,80

machine en schijf niet inbegrepen / machine et disque non incluse

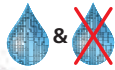
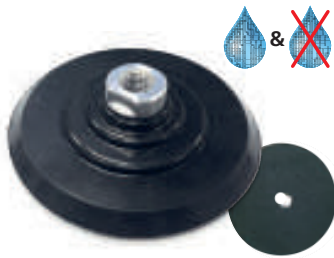

Rubber steunschijf "Flexibel" Support pour patins de polissage "Flexible"



code								min.	€
DX 745100		5420000034617	M14	100 mm	0,101 kg	-	1	1	17,97
DX 745125		5420000068605	M14	125 mm	0,170 kg	-	1	1	20,40



Diamantpads - nat polijsten • Patins de polissage - polissage à eau



code								min.	€
<i>Prijs per stuk • Prix par pièce</i>									
DX 752105		5420000071650	50	100 mm	0,140 kg	-	1	1	15,00
DX 752110		5420000071667	100	100 mm	0,140 kg	-	1	1	15,00
DX 752120		5420000071674	200	100 mm	0,140 kg	-	1	1	15,00
DX 752140		5420000071681	400	100 mm	0,140 kg	-	1	1	15,00
DX 752180		5420000071698	800	100 mm	0,140 kg	-	1	1	15,00
DX 752195		5420000071704	1500	100 mm	0,140 kg	-	1	1	15,00



Steunschijf Disque de support

Toepassing • Application

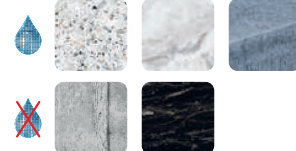

K100
K200

K400
K800

K1500
K3000

Grof
Grossier

>> **3-Steps**

>> Zacht
Doux



Set diamant polijstpads "3-Steps" + steunschijf Patins de polissage en set "3-Steps" + disque de support



code								min.	€
DX 750814		5420000071445	H1 → H3	100 mm	0,246 kg	-	1	1	87,00
DX 750904		5420000071438	H1 → H3	125 mm	0,390 kg	-	1	1	89,00



DX 750904

DX 750814



Eenvoudige montage
Installation facile



Honingraatstructuur op basis van kunstharz
Structure en nid d'abeille à base de résine synthétique



Snel polijsten
Polissage rapide



Min. 3000 rpm
Max. 4500 rpm

Toepassing • Application



Graniet
Granite

Beton
Béton

Marmer
Marbre

Arduin
Pierre bleue



Flexibele schijf
Disque flexible

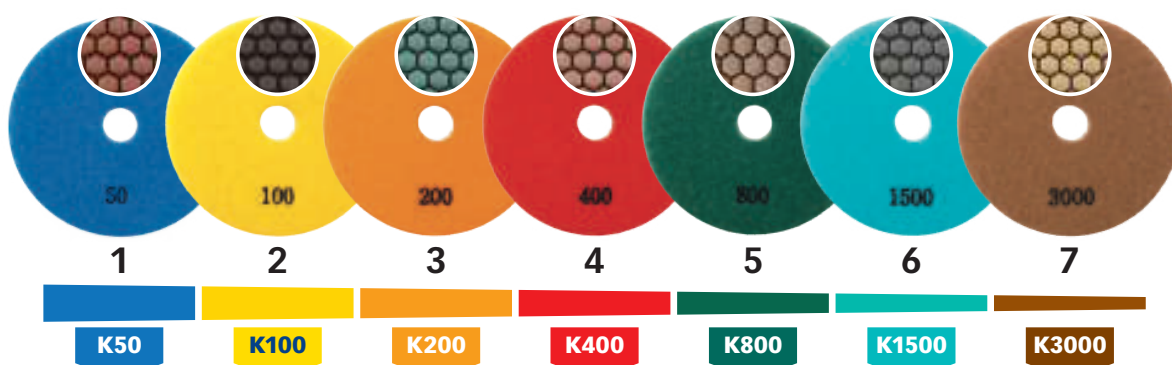

Grof
Grossier

> > > > > > > **7-Steps** > > > > > > >

Zacht
Doux

Diamant polijstpads "7-STEPS" Patins de polissage "7-STEPS"



code			#K						min.	€
DX 751005		5420000068537	50		125 mm	0,030 kg	-	1	1	15,50
DX 751010		5420000068544	100		125 mm	0,030 kg	-	1	1	15,50
DX 751020		5420000068551	200		125 mm	0,030 kg	-	1	1	15,50
DX 751040		5420000068568	400		125 mm	0,030 kg	-	1	1	15,50
DX 751080		5420000068575	800		125 mm	0,030 kg	-	1	1	15,50
DX 751150		5420000068582	1500		125 mm	0,030 kg	-	1	1	15,50
DX 751300		5420000068599	3000		125 mm	0,030 kg	-	1	1	15,50
8-delige set (50 - 3000 + steunschijf) • set de 8 pièces (50 - 3000 + disque de support)										
DX 751908		5420000068612	50 - 3000		125 mm	0,430 kg	-	1	1	122,00



DX 751908
K50 + K100 + K200 + K400 +
K800 + K1500 + K3000



+
Steunschijf
Disque de support

Diamant handschuurblok Bloc de ponçage diamanté

code			#K						min.	€
DX 757050		5420000071391	50		90 x 55 mm	0,040 kg	-	100	1	14,25
DX 757100		5420000071407	100		90 x 55 mm	0,040 kg	-	100	1	14,25
DX 757200		5420000071414	200		90 x 55 mm	0,040 kg	-	100	1	14,25
DX 757400		5420000071421	400		90 x 55 mm	0,040 kg	-	100	1	14,25



STD - SOFT
PRO CONSTRUCTION

EN 13236

Abrasieve, zachte voegen
Abrasifs, joints tendre

code											
			mm	mm	mm	mm				€	
DX 714078		5420000071520	78	22,2	7,0	6,35	210 gr	-	1	1	48,00
DX 714125		5420000024359	125	22,2	7,0	6,35	346 gr	-	1	1	63,20

JC - SOFT
PREMIUM CONSTRUCTION

EN 13236

 Tanden zijn verzet
 Dents alternées

Abrasieve, zachte voegen
Abrasifs, joints tendre

code											
			mm	mm	mm	mm				€	
DX 712125		5420000020580	125	22,2	7,5	8(4+4)	455 gr	-	1	1	96,00

JC - HARD
PREMIUM CONSTRUCTION

EN 13236

 Tanden zijn verzet
 Dents alternées

Harde betonvoegen
Joints durs en béton

code											
			mm	mm	mm	mm				€	
DX 710115		5420000020559	115	22,2	7,5	8(4+4)	368 gr	-	1	1	79,40
DX 710125		5420000020566	125	22,2	7,5	8(4+4)	446 gr	-	1	1	94,50



PRODIAXO QUICK SEARCH 3-STEP

1 BEPAAL DE BOORAANSLUITING DÉTERMINER LE RACCORDEMENT DU FORET



M16

M14

R 1/2 "

1 1/4 "

2 NATBOREN OF DROOGBOREN FORAGE À EAU OU À SEC



VOOR GEBRUIK ZONDER WATERKOELING:
BAKSTEEN EN ZACHTE STEENSOORTEN
POUR LE FORAGE À SEC :
BRIQUES ET PIERRES TENDRES



VOOR GEBRUIK MET WATERKOELING:
BETON EN HARDE STEENSOORTEN
POUR LE FORAGE AVEC REFRROIDISSEMENT À EAU :
BÉTON ET PIERRES DURES

3 BEPAAL HET KWALITEITSNIVEAU DÉTERMINER LE NIVEAU DE QUALITÉ

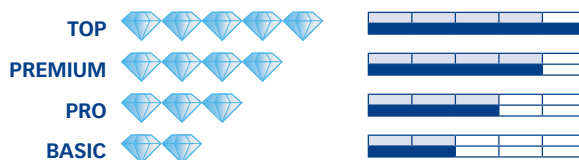

— LEVENSDUUR / LONGÉVITÉ
— PERFORMANCE



**KLOPFUNCTIE NIET GEBRUIKEN
NE PAS UTILISER LA FONCTION PERCUSSION**



DROGBOREN / FORAGE À SEC

ZONDER STOF AFZUIGING / SANS ASPIRATION

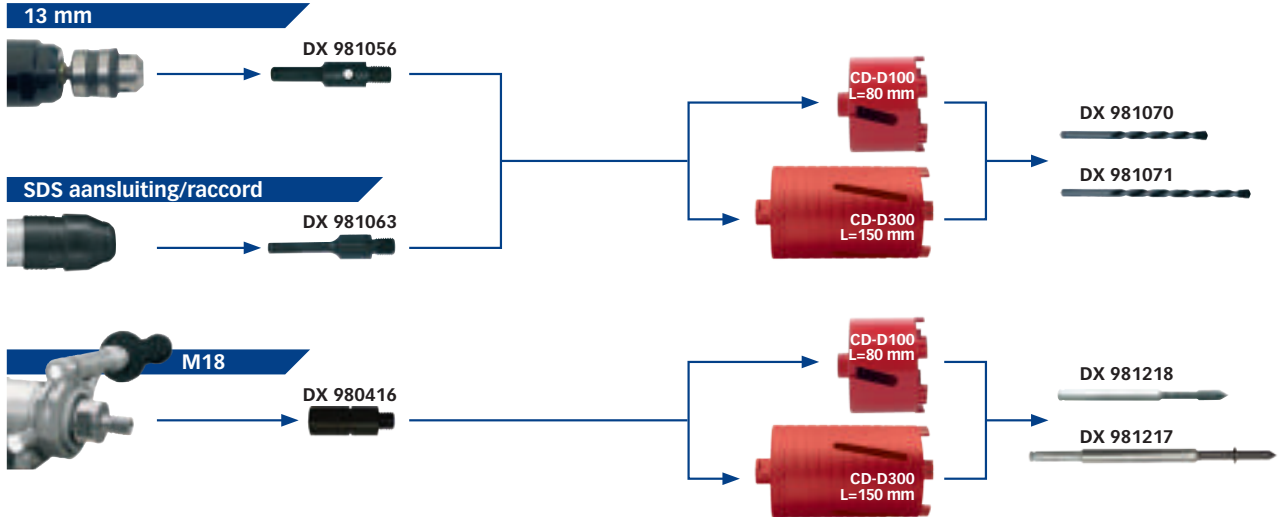

DROGBOREN / FORAGE À SEC

MET STOF AFZUIGING / AVEC ASPIRATION

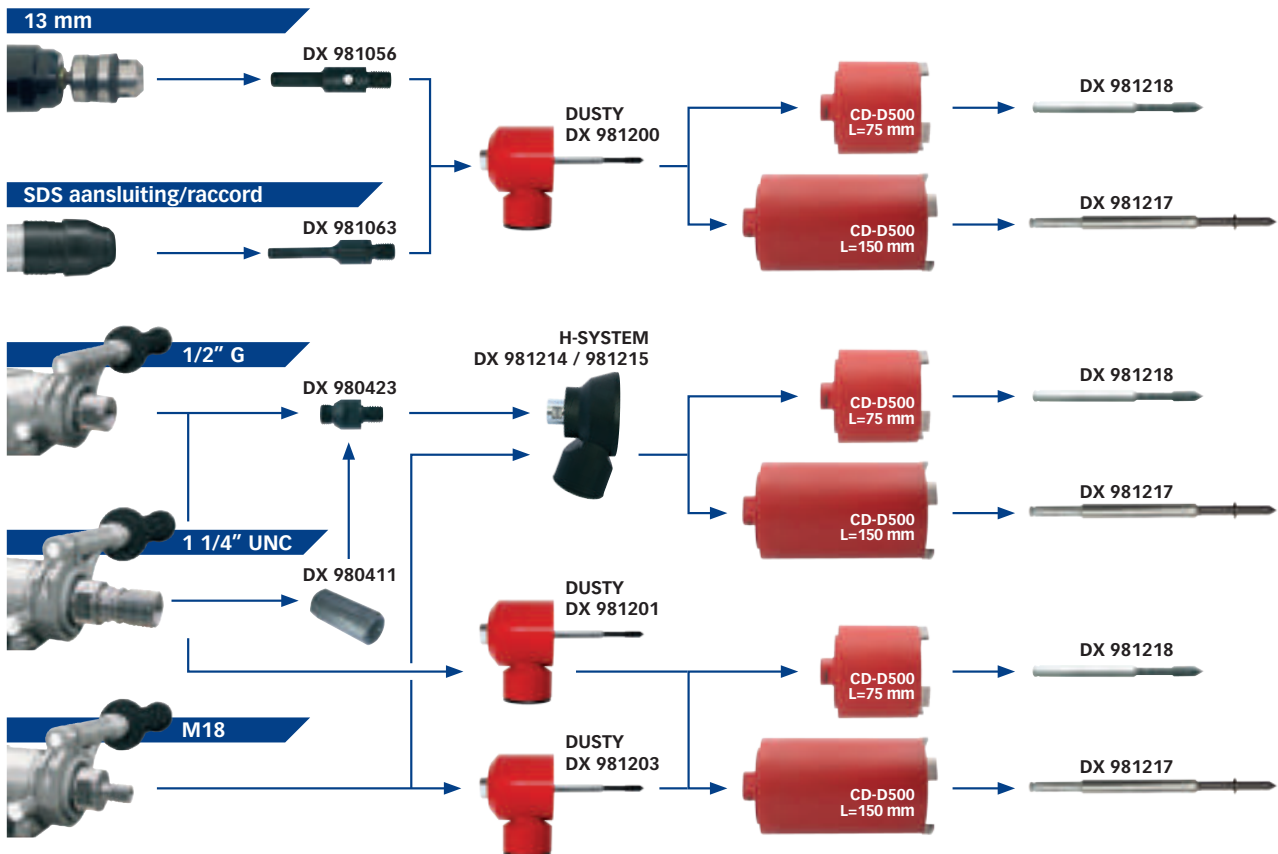

SERIE CD - D150 TOP CONSTRUCTION



M16	60 mm	9 mm 3,8 mm		
-----	-------	----------------	--	--

Baksteen • Briques

code		Ø	#				min.	€	
		mm							
DX 803268		5420000029675	68	4	416 gr	-	1	1	119,00
DX 803282		5420000029682	82	4	548 gr	-	1	1	135,00
DX 803302		5420000029699	102	5	600 gr	-	1	1	173,00



**JAGUAR
segment**

**Very fast - Long-life
Supercooled - Less friction**



SERIE CD - D100 PREMIUM CONSTRUCTION



M16	80 mm	10 mm 3,8 mm			
-----	-------	-----------------	--	--	--

Baksteen • Briques

code		Ø	#				min.	€	
		mm							
DX 802068		5420000020627	68	3	433 gr	-	1	1	55,50
DX 802082		5420000020634	82	4	549 gr	-	1	1	69,30
DX 803102		5420000025370	102	6	597 gr	-	1	1	142,00



SERIE CD - D300 PREMIUM CONSTRUCTION



M16	150 mm	10 mm 3,8 mm			
-----	--------	-----------------	--	--	--

Baksteen • Briques

code		Ø	#				min.	€	
		mm							
DX 811052		5420000020658	52	4	448 gr	-	1	1	75,10
DX 811068		5420000020665	68	4	647 gr	-	1	1	82,20
DX 811082		5420000020672	82	5	805 gr	-	1	1	92,80
DX 811102		5420000020689	102	6	1158 gr	-	1	1	118,00
DX 811132		5420000020696	132	6	1761 gr	-	1	1	143,00



DROOGBOREN / COURONNES À SEC

Gebruikt met een stofafzuigstelsysteem / Utilisé avec un système d'extraction de poussière

SERIE CD - D500

PREMIUM CONSTRUCTION

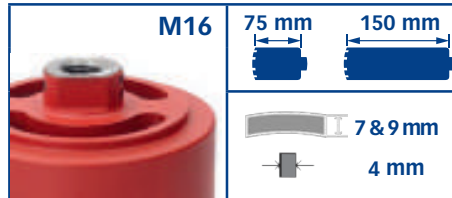

DX 805...

 Stofsleuven in deksel voor stofafzuigunit
 Rainure d'aspiration dans la flasque pour
 carter d'aspiration

Baksteen • Briques

code							min.	€
------	--	--	--	--	--	--	------	---

L = 75 mm									
DX 805068		5420000022065	68	4	360 gr	-	1	1	113,00
DX 805076		5420000023680	76	4	440 gr	-	1	1	116,00
DX 805082		5420000022072	82	4	475 gr	-	1	1	120,00
DX 805102		5420000020641	102	4	729 gr	-	1	1	150,00
DX 805105		5420000023741	105	4	956 gr	-	1	1	159,00
DX 805132		5420000022423	132	5	1000 gr	-	1	1	232,00

L = 150 mm									
DX 817062		5420000020733	62	4	658 gr	-	1	1	117,00
DX 817072		5420000020740	72	4	807 gr	-	1	1	130,00
DX 817082		5420000020757	82	4	902 gr	-	1	1	136,00
DX 817092		5420000020764	92	4	1271 gr	-	1	1	151,00
DX 817102		5420000020771	102	4	1338 gr	-	1	1	168,00
DX 817112		5420000020788	112	4	1506 gr	-	1	1	184,00
DX 817122		5420000020795	122	4	1700 gr	-	1	1	207,00
DX 817132		5420000022416	132	5	1942 gr	-	1	1	232,00

L = 150 mm									
DX 817030		5420000020702	30	0	284 gr	-	1	1	86,80
DX 817040		5420000020719	40	0	392 gr	-	1	1	99,30
DX 817052		5420000020726	52	3	619 gr	-	1	1	107,00

 Andere diameters of boren met stofgaten op bestelling
 Autres diamètres ou couronnes avec trous d'évacuation de la poussière sur demande

 DX 817030
 DX 817040
 DX 817052

Centreeropname met uitdrijving
Porte-outil de centrage avec chasse-cône

code							min.	€	
DX 981056		5420000021549	6-kant / 6-pans	M16 (M)	150 gr	-	10	1	16,96
DX 981063		5420000021556	SDS+ aansluiting raccord	M16 (M)	150 gr	-	10	1	20,81

Centreerboor voor centreeropname
Mèche de centrage pour porte-outil de centrage

code									min.	€	
DX 981070		5420000021563	8	7	120	70	38 gr	-	10	1	8,90
DX 981071		5420000022607	8	7	250	190	64 gr	-	1	1	23,57

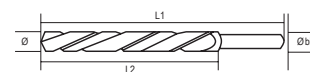

DROOGBOREN / COURONNES À SEC

SYSTEM - H / DUSTY



Stofafzuigunit • Carter d'aspiration
SYSTEM-H

code							min.	€
DX 981214		5420000024007	M16 (F) / M16 (M)	383 gr	-	1	1	95,30
DX 981215		5420000024014	M18 (F) / M16 (M)	383 gr	-	1	1	95,30



Stofafzuigunit • Carter d'aspiration
DUSTY

code								min.	€
DX 981200		5420000022317	M16 (F)	M16 (M)	1050 gr	-	1	1	199,00
DX 981201		5420000022324	R 1/2" (M)	M16 (M)	1205 gr	-	1	1	199,00
DX 981203		5420000022614	M18 (F)	M16 (M)	1097 gr	-	1	1	199,00



Centreerpen • Axe de centrage

code								min.	€
			Ø						
			mm	mm					
DX 981218		5420000033733	8	150	65 gr	-	1	1	33,20
DX 981217		5420000024588	8	230	120 gr	-	1	1	37,05

Door een speciaal afzuigstelsysteem wordt het stof uit het boorgat afgevoerd, dit verhoogt de levensduur van de boorkronen. Snel en gemakkelijk reinigen door gereedschapsloos afnemen van de afzuigunit.

Ce système aspire les poussières et prolonge la durée de vie de la couronne de forage. Nettoyage simple et rapide, aucun outil nécessaire lors du démontage de l'unité d'aspiration.

DROOGBOREN / COURONNES À SEC

SERIE CD - D555 WAX TOP GRANITE



Vacuum Brazed



TOP!



DRYWAX



WAX in de kop van de boor
WAX dans la tête de la couronne



code			Ø				min.	€
			mm					
DX 801904		5420000065055	4	23 gr	-	10	1	9,85
DX 801906		5420000029293	6	26 gr	-	10	1	9,85
DX 801908		5420000029309	8	30 gr	-	10	1	9,85
DX 801910		5420000029316	10	32 gr	-	10	1	9,85
DX 801912		5420000029323	12	38 gr	-	10	1	9,85
6 - delige set • Jeu de 6 pièces								
DX 801999	koffer/coffre	5420000034808	6, 8, 10, 12, 14	713 gr	-	1	1	95,00
+ guide (inox)								

SERIE CD - D530 PRO GRANITE

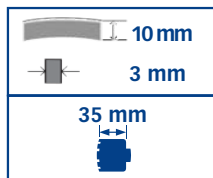

M14



Vacuum Brazed



DRYWAX

NEW

Keramik, graniet, marmar • Céramique, granite, marbre

code			Ø				min.	€
			mm					
DX 800706		5420000074644	6	48 gr	-	10	1	8,15
DX 800708		5420000074651	8	54 gr	-	10	1	8,25
DX 800710		5420000074668	10	58 gr	-	10	1	8,50
DX 800712		5420000074675	12	60 gr	-	10	1	8,95



Display per 12 st.
Display par 12 pcs

DX 801985



Cooling Wax voor droogboren
Cire de refroidissement pour couronnes à sec

code							min.	€
DX 801985	vrac	5420000062344	20 ml	40 gr	-	12	12	4,30
DX 801980		5420000074781	2 x 40 ml	124 gr	-	12	1	12,60

DROOGBOREN / COURONNES À SEC

SERIE CD - D555 PREMIUM GRANITE

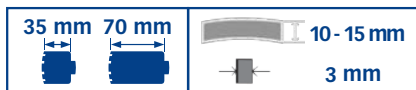

Keramik, graniet, marmor • Céramique, granite, marbre

code						€
			mm			

L = 35 MM

DX 801006		5420000037083	6	25 gr	-	10	1	14,84
DX 801008		5420000037090	8	38 gr	-	10	1	16,44
DX 801010		5420000037106	10	42 gr	-	10	1	18,00
DX 801012		5420000037113	12	45 gr	-	10	1	19,10
DX 801014		5420000058750	14	55 gr	-	10	1	20,63
DX 801016		5420000074682	16	64 gr	-	10	1	20,90
DX 801027		5420000023758	27	114 gr	-	1	1	21,70
DX 801035		5420000023765	35	161 gr	-	1	1	27,80
DX 801040		5420000063464	40	185 gr	-	1	1	31,60
DX 801050		5420000023772	50	222 gr	-	1	1	39,25
DX 801060		5420000023789	60	282 gr	-	1	1	46,90
DX 801068		5420000063341	68	300 gr	-	1	1	53,00
DX 801075		5420000023796	75	351 gr	-	1	1	58,30
DX 801080		5420000034761	80	398 gr	-	1	1	62,10
DX 801083		5420000063358	83	400 gr	-	1	1	64,40
DX 801090		5420000034778	90	459 gr	-	1	1	69,80
DX 801102		5420000027206	102	487 gr	-	1	1	78,90
DX 801112		5420000034785	112	519 gr	-	1	1	86,60
DX 801125		5420000034792	125	588 gr	-	1	1	96,50

L = EXTRA LONG 70 MM

DX 801527		5420000029453	27	166 gr	-	1	1	36,00
DX 801535		5420000029460	35	209 gr	-	1	1	46,65
DX 801550		5420000029477	50	299 gr	-	1	1	65,00
DX 801560		5420000029484	60	370 gr	-	1	1	77,90
DX 801570		5420000029491	70	439 gr	-	1	1	95,00
DX 801582		5420000029507	82	532 gr	-	1	1	108,00

SETS L = 35 MM

5-delige SET • Jeu de 5 pièces : Ø 27, 35, 50, 60, 75 mm

DX 801000	koffer/coffre	5420000022461	SET	1430 gr	-	1	1	225,00
-----------	---------------	---------------	-----	---------	---	---	---	--------

7-delige SET • Jeu de 7 pièces :

Ø 2 x 6, 2 x 8, 1 x 10, 1 x 12 mm + adapter (DX 981060) • + adaptateur (DX 981060)

DX 800975	koffer/coffre	5420000046825	SET	560 gr	-	1	1	139,00
-----------	---------------	---------------	-----	--------	---	---	---	--------

5-delige SET • Jeu de 5 pièces :

Ø 2 x 6, 2 x 8 mm + adapter (DX 981060) • + adaptateur (DX 981060)

DX 800980	koffer/coffre	5420000046849	SET	458 gr	-	1	1	96,00
-----------	---------------	---------------	-----	--------	---	---	---	-------

Adapter - verloopstuk • Adaptateur - Raccord de réduction

DX 981060		5420000046832	6-kant • 6-pans M14 (M)	150 gr	-	1	1	12,80
-----------	--	---------------	----------------------------	--------	---	---	---	-------

new design

DRYWAXPRO



DX 801000



DX 800975

new design

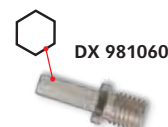

DX 981060

CR-100

PREMIUM CONSTRUCTION



Vacuum
Brazed

M14

Diamant kantenfrees voor het afronden van porselein, graniet, marmer, keramiek, natuursteen, tegels
Fraise diamantée pour fraisage du grès cérame, granit, marbre, en céramique, pierre naturelle, carrelage

NEW

DX 704010

GRIT
#50



code								min.	€	
		mm	mm							
DX 704010		5420000074699	10-25	50	M14	175 gr	-	10	1	24,00
DX 704020		5420000062740	20	50	M14	235 gr	-	10	1	53,60



new design DX 704020



GRIT
#80

Diamant puntfrees voor porselein, graniet, marmer, keramiek, natuursteen, tegels
Fraise à pointe diamantée pour porcelaine, granite, marbre, grès cérame, pierre naturelle, carrelage

code								min.	€	
		mm	mm							
DX 704535		5420000069886	5-35	35	M14	120 gr	-	10	1	21,00



new design

Afschuiven en ontbramen
Chanfreiner et ébavurer



Diamant frees voor porselein, graniet, marmer, keramiek, natuursteen, tegels
Fraise diamantée pour porcelaine, granite, marbre, grès cérame, pierre naturelle, carrelage

code								min.	€	
		mm	mm							
DX 704675		5420000069893	35-75	56	M14	850 gr	-	5	1	41,00

GRIT
#80



Afschuiven om bestaande gaten te vergroten, slijpen en polijsten
Biseauter pour agrandir, meuler et polir les trous existants



new design

CD-DI835 / CUBIX TECH PREMIUM CONSTRUCTION

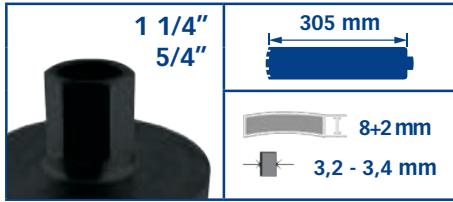

i Best eerst de boor voorslijpen voor een beter resultaat in gewapend beton
Affûter les couronnes pour un meilleur résultat dans le béton armé

SOFT-IMPACT Cubix Tech. Diamant boorkronen Couronnes diamantées SOFT-IMPACT Cubix Tech

code			Ø		#				min.	€
			mm	mm						
DX 835032		5420000069961	32	3,2	5	0,560 kg	-	1	1	110,00
DX 835042		5420000069978	42	3,2	5	0,770 kg	-	1	1	110,00
DX 835052		5420000069985	52	3,4	5	1,000 kg	-	1	1	115,00
DX 835062		5420000069992	62	3,4	5	1,230 kg	-	1	1	131,00
DX 835072		5420000070004	72	3,4	6	1,480 kg	-	1	1	141,00
DX 835076		5420000070127	76	3,4	6	1,640 kg	-	1	1	143,00
DX 835082		5420000070011	82	3,4	6	1,800 kg	-	1	1	146,00
DX 835092		5420000070028	92	3,4	6	2,010 kg	-	1	1	156,00
DX 835102		5420000070035	102	3,4	7	2,310 kg	-	1	1	161,00
DX 835112		5420000070042	112	3,4	7	2,610 kg	-	1	1	166,00
DX 835122		5420000070059	122	3,4	8	2,930 kg	-	1	1	184,00
DX 835132		5420000070066	132	3,4	8	3,260 kg	-	1	1	200,00
DX 835142		5420000070073	142	3,4	8	3,610 kg	-	1	1	273,00
DX 835152		5420000070080	152	3,4	8	4,530 kg	-	1	1	296,00
DX 835162		5420000070097	162	3,4	9	4,950 kg	-	1	1	328,00
DX 835182		5420000070110	182	3,4	9	5,910 kg	-	1	1	389,00

Geschikt voor
Adapté pour

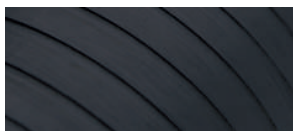

Extra stofverwijdering dankzij de groeven
Extraction supplémentaire de la poussière grâce aux rainures

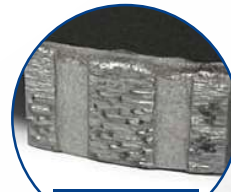

New **CUBIX** Technology



Gebruik met de Eibenstock machines ESD 162 en ESD 200 voor het beste resultaat → Zie blz. 13 & 14

À utiliser avec les machines Eibenstock ESD 162 et ESD 200 pour un meilleur résultat → Voir pg. 13 & 14



**ALSO FOR
REINFORCED
CONCRETE**

Centreerpen • Axe de centrage

code			Ø					min.	€
			mm	voor/pour					
EE 36394	vrac	4026851006431	8	max. L 350 mm Ø 132-250 mm	203 gr	-	1	1	71,00



SERIE CD - D800

PREMIUM CONSTRUCTION

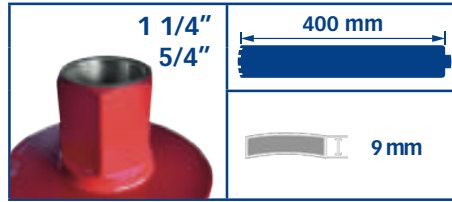

**NIET GESCHIKT VOOR BETON !
PAS APTE POUR LE BÉTON !**

Baksteen hard en middelmatig • Briques durs et demi-dur

code			Ø		#				min.	€
			mm	mm						
DX 824032		5420000026438	32	2,5	3	872 gr	-	1	1	90,90
DX 824042		5420000026445	42	2,5	4	934 gr	-	1	1	103,00
DX 824052		5420000026452	52	3,5	3	1367 gr	-	1	1	116,00
DX 824062		5420000026469	62	3,5	4	1722 gr	-	1	1	126,00
DX 824082		5420000026476	82	3,5	4	2230 gr	-	1	1	145,00
DX 824092		5420000026483	92	3,5	4	2484 gr	-	1	1	164,00
DX 824102		5420000026490	102	3,5	4	2750 gr	-	1	1	180,00
DX 824112		5420000026506	112	3,5	4	3198 gr	-	1	1	199,00
DX 824122		5420000026513	122	3,5	4	3329 gr	-	1	1	220,00
DX 824132		5420000026520	132	3,5	5	3965 gr	-	1	1	241,00
DX 824152		5420000026537	152	3,5	5	4368 gr	-	1	1	299,00
DX 824162		5420000028784	162	3,5	6	5300 gr	-	1	1	352,00



Stofafzuigunit • Carter d'aspiration



code								min.	€
EE 35230	vrac	4026851008756	M18 (F)	1 1/4" (M)	1030 gr	-	1	1	149,00

Centreerpen voor stofafzuigunit • Axe de centrage pour carter d'aspiration







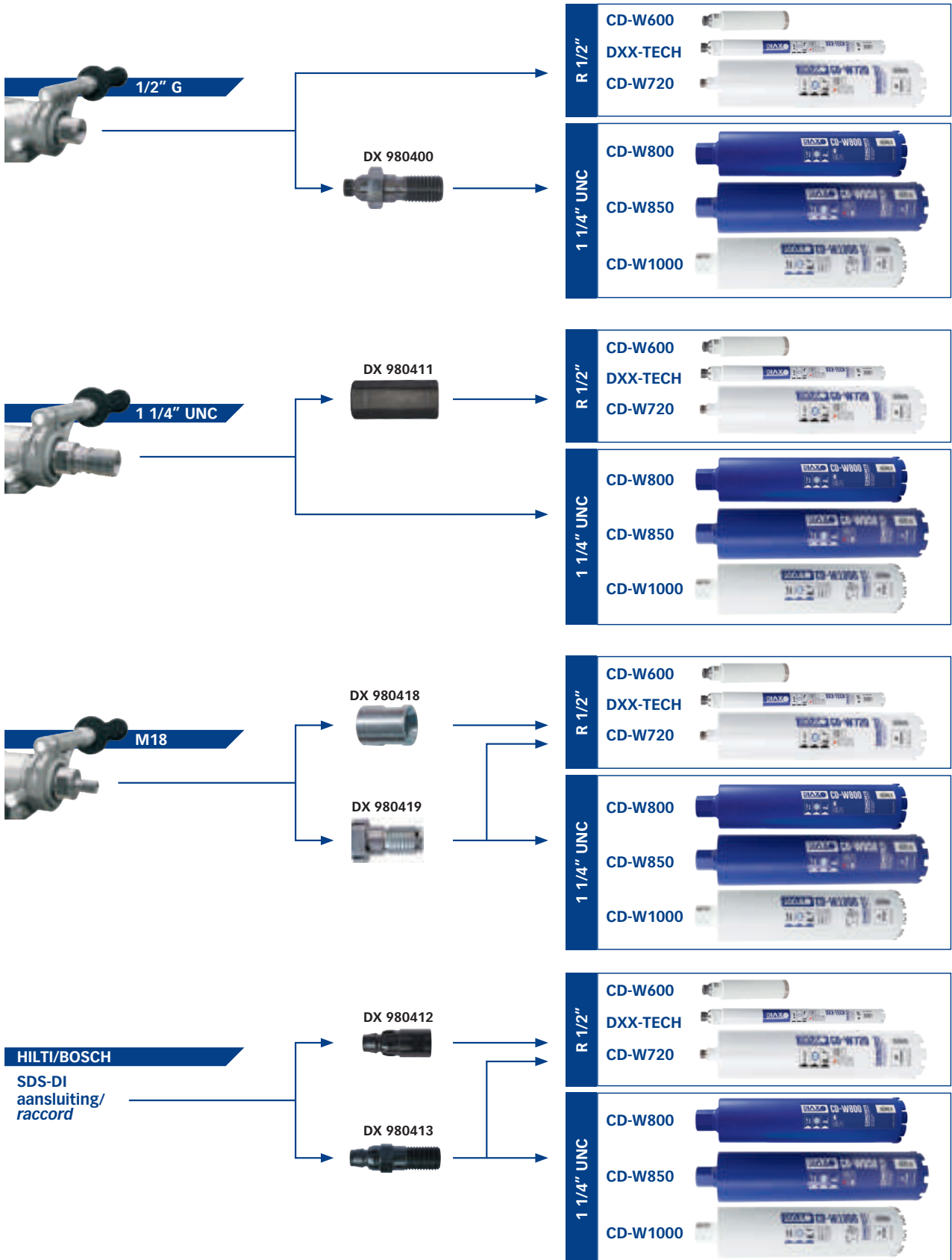

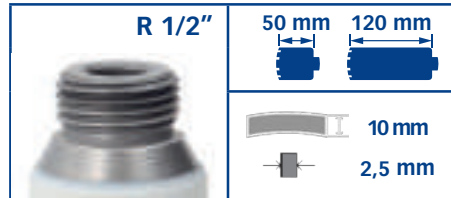









code			Ø					min.	€
EE 36391	vrac	4026851005472	8	voor/pour	1096 gr	-	1	1	79,00
				max. L 450 mm Ø 132-202 mm					



NATBOREN / FORAGE À EAU



BOORKRONEN / COURONNES
CD - W600
PREMIUM GRANITE

Graniet, natuursteen, gres tegel • Granite, pierre naturelle, carrelage en grès

code			Ø	#				min.	€
mm									
L = 50 MM									
DX 920006		5420000021389	6,3	○	201 gr	-	1	1	63,50
DX 920008		5420000021396	8,3	○	200 gr	-	1	1	69,10
DX 920010		5420000021402	10	○	202 gr	-	1	1	75,90
L = 120 MM									
DX 920012		5420000021419	12	○	219 gr	-	1	1	78,90
DX 920014		5420000021426	14	○	215 gr	-	1	1	83,00
DX 920016		5420000021433	16	○	192 gr	-	1	1	89,10
DX 920018		5420000021440	18	○	206 gr	-	1	1	92,60
DX 920020		5420000021457	20	○	203 gr	-	1	1	104,00
DX 920025		5420000021464	25	○	233 gr	-	1	1	115,00
DX 920032		5420000021471	32	○	280 gr	-	1	1	128,00
DX 920036		5420000021488	36	○	314 gr	-	1	1	138,00
DX 920042		5420000021495	42	○	347 gr	-	1	1	145,00
DX 920051		5420000021501	51	5	554 gr	-	1	1	155,00

Gebruik van machine END 1550 P of EFB 125 P aanbevolen → Zie blz 15
Utilisation de la machine END 1550 P ou EFB 125 P recommandée → Voir pg 15





**Herbezetting boorkronen
alle merken (gesoldeerd)**

Naast het programma in deze brochure van de meest gangbare boren levert PRODIAXO u ook specifieke boren met afwijkende diameter en/of lengtes op aanvraag

**Resegmentation des couronnes
toutes marques (soudé)**

Mis à part les couronnes qui sont mentionnées dans la brochure, il est possible d'en commander avec des diamètres et longueurs différentes et ceci sur demande

BOORKRONEN MET LASERGELASTE SEGMENTEN COURONNES AVEC SEGMENTS SOUDÉS AU LASER

DXX - TECH

TOP CONSTRUCTION

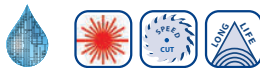
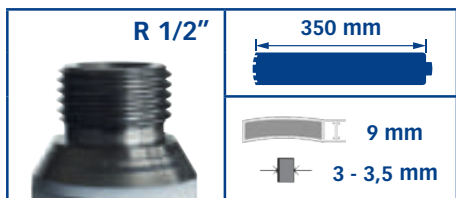

Beton, gewapend beton en aggregaten • Béton, béton armé et agrégats

code			Ø		#				min.	€
			mm	mm						
DX 905018		5420000046207	18	3	3	650 gr	-	1	1	80,50
DX 905020		5420000046214	20	3	4	670 gr	-	1	1	80,50
DX 905022		5420000046221	22	3	4	680 gr	-	1	1	91,90
DX 905025		5420000046238	25	3	5	750 gr	-	1	1	95,80
DX 905028		5420000046245	28	3	6	790 gr	-	1	1	99,60
DX 905030		5420000046252	30	3	6	850 gr	-	1	1	103,00
DX 905032		5420000046269	32	3,5	4	950 gr	-	1	1	123,00
DX 905035		5420000046276	35	3,5	5	980 gr	-	1	1	130,00



Fast cutting
Long-life
Reinforced concrete
Top quality
Good price



CD - W720

PREMIUM CONSTRUCTION

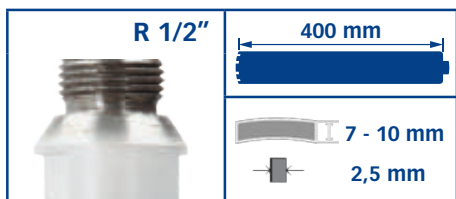

Dunwandig : (gemakkelijk uit de hand boren)
Fine : (facile à utiliser avec machine portative)







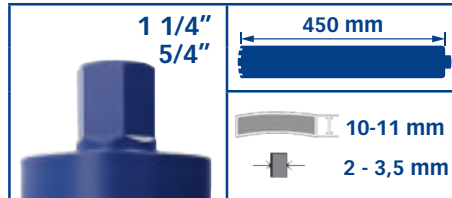

















Beton, gewapend beton en aggregaten • Béton, béton armé et agrégats

code			Ø		#				min.	€
			mm	mm						
DX 908030		5420000061323	30	7	6	750 gr	-	1	1	97,90
DX 908040		5420000046290	40	7	3	1050 gr	-	1	1	99,00
DX 908046		5420000046306	46	7	6	1150 gr	-	1	1	100,00
DX 908051		5420000046313	51	10	5	1250 gr	-	1	1	105,00
DX 908056		5420000046320	56	10	5	1350 gr	-	1	1	118,00
DX 908061		5420000046337	61	10	6	1450 gr	-	1	1	122,00
DX 908068		5420000046344	68	10	6	1550 gr	-	1	1	166,00
DX 908076		5420000046368	76	10	7	1750 gr	-	1	1	172,00
DX 908081		5420000046375	81	10	8	1950 gr	-	1	1	177,00
DX 908086		5420000046382	86	10	8	2050 gr	-	1	1	183,00
DX 908091		5420000046399	91	10	9	2150 gr	-	1	1	185,00
DX 908101		5420000046405	101	10	9	2350 gr	-	1	1	198,00
DX 908105		5420000046412	105	10	9	2450 gr	-	1	1	237,00
DX 908111		5420000046429	111	10	10	2550 gr	-	1	1	218,00
DX 908121		5420000046436	121	10	11	2650 gr	-	1	1	235,00
DX 908131		5420000046443	131	10	11	2750 gr	-	1	1	275,00



BOORKRONEN / COURONNES
CD - W850
PREMIUM CONSTRUCTION

 Dikwandige buis (voor op statief)
 Paroi épaisse (pour trépied)

Beton, gewapend beton (natzagen) • Béton, béton armé (forage à l'eau)

code			Ø	#				min.	€
			mm						
DX 914025		5420000036741	25	0	600 gr	-	1	1	91,40
DX 914028		5420000041998	28	0	750 gr	-	1	1	107,00
DX 914030		5420000036758	30	0	800 gr	-	1	1	110,00
DX 914035		5420000036765	35	0	900 gr	-	1	1	122,00
DX 914040		5420000036772	40	5	1200 gr	-	1	1	129,00
DX 914052		5420000036789	52	5	1600 gr	-	1	1	133,00
DX 914062		5420000036796	62	6	1800 gr	-	1	1	136,00
DX 914072		5420000036802	72	7	2200 gr	-	1	1	158,00
DX 914082		5420000036819	82	7	2400 gr	-	1	1	172,00
DX 914092		5420000036826	92	8	2700 gr	-	1	1	185,00
DX 914102		5420000036833	102	9	3100 gr	-	1	1	205,00
DX 914112		5420000036840	112	9	3400 gr	-	1	1	214,00
DX 914122		5420000036857	122	10	3600 gr	-	1	1	227,00
DX 914127		5420000036864	127	10	3900 gr	-	1	1	235,00
DX 914132		5420000036871	132	11	4100 gr	-	1	1	246,00
DX 914142		5420000036888	142	11	4600 gr	-	1	1	265,00
DX 914152		5420000036895	152	12	5700 gr	-	1	1	283,00
DX 914162		5420000036901	162	13	6100 gr	-	1	1	297,00
DX 914172		5420000036918	172	13	6400 gr	-	1	1	323,00
DX 914182		5420000036925	182	14	7100 gr	-	1	1	330,00
DX 914200	vrac	5420000036932	200	15	7800 gr	-	1	1	330,00
DX 914225	vrac	5420000036949	225	16	9100 gr	-	1	1	482,00
DX 914250	vrac	5420000036956	250	17	11000 gr	-	1	1	516,00
DX 914300	vrac	5420000036963	300	22	16500 gr	-	1	1	585,00

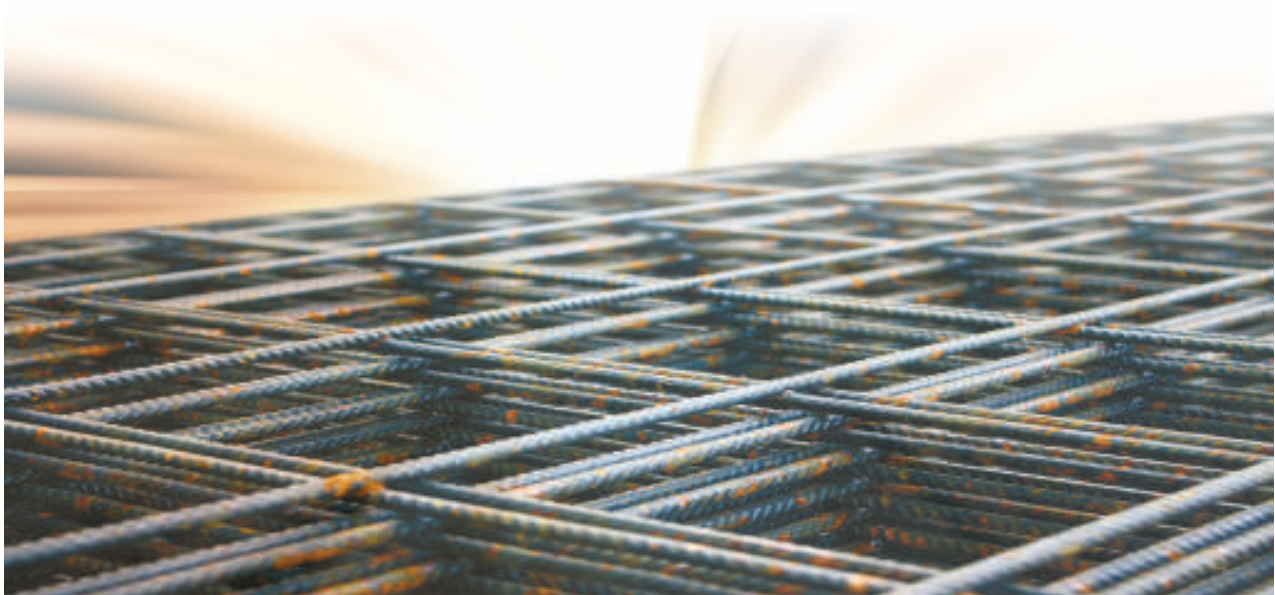

**30%
Faster
Long-life**

**LASERGEST
SOUDÉS LASER**

BOORKRONEN / COURONNES

CD - W800

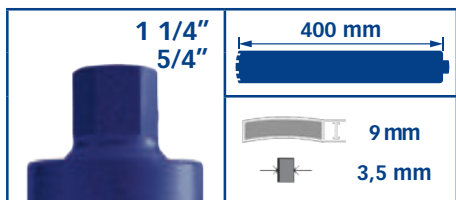
PREMIUM CONSTRUCTION



Dikwandige buis (voor op statief)
Paroi épaisse (pour trépied)

Beton, gewapend beton • Béton, béton armé

code			Ø	#			min.	€
			mm					
DX 915350	vrac	5420000021334	350	23	18300 gr	-	1	739,00
DX 915400	vrac	5420000021341	400	28	26900 gr	-	1	977,00
DX 915450	vrac	5420000021358	450	30	32500 gr	-	1	1070,00
DX 915500	vrac	5420000021365	500	30	38700 gr	-	1	1146,00
DX 915600	vrac	5420000021372	600	33	55700 gr	-	1	1185,00



CD - W1000

PREMIUM CONSTRUCTION

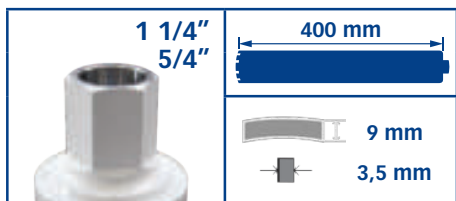

ALSO FOR SUPER
REINFORCED
CONCRETE !

Beton, gewapend beton • Béton, béton armé

code			Ø	#			min.	€
			mm					
DX 912052		5420000024816	52	5	1385 gr	-	1	132,00
DX 912057		5420000024823	57	5	1500 gr	-	1	134,00
DX 912062		5420000024830	62	6	1682 gr	-	1	161,00
DX 912067		5420000024847	67	6	1758 gr	-	1	189,00
DX 912072		5420000024854	72	7	2010 gr	-	1	195,00
DX 912082		5420000024878	82	8	2272 gr	-	1	207,00
DX 912087		5420000024885	87	8	2478 gr	-	1	221,00
DX 912092		5420000024892	92	9	2435 gr	-	1	226,00
DX 912102		5420000024908	102	9	2834 gr	-	1	236,00
DX 912112		5420000024915	112	10	3442 gr	-	1	261,00
DX 912122		5420000029064	122	11	3411 gr	-	1	295,00
DX 912132		5420000029071	132	11	3751 gr	-	1	305,00
DX 912142		5420000029088	142	12	4573 gr	-	1	316,00
DX 912152		5420000029095	152	13	5000 gr	-	1	346,00
DX 912160		5420000029101	160	14	5150 gr	-	1	377,00
DX 912170		5420000029118	170	14	5150 gr	-	1	385,00
DX 912180		5420000029125	180	15	6150 gr	-	1	410,00
DX 912200	vrac	5420000029132	200	15	7600 gr	-	1	412,00
DX 912220	vrac	5420000029149	220	17	10800 gr	-	1	593,00
DX 912250	vrac	5420000029156	250	18	13100 gr	-	1	612,00
DX 912300	vrac	5420000029163	300	20	17200 gr	-	1	681,00
DX 912350	vrac	5420000029170	350	23	21800 gr	-	1	808,00



Very fast
Long-life
Super cooled
Less friction

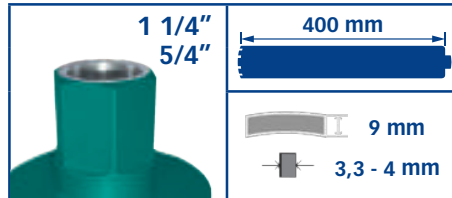

BOORKRONEN / COURONNES
CD - W900 Soft
 PREMIUM CONSTRUCTION

**SPECIAL
ASPHALT**

Asfalt • Asphalte

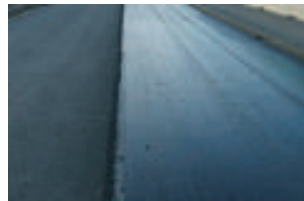
code									min.	€
			mm	mm						
DX 917032		5420000028791	32	3,3	3	1019 gr	-	1	1	96,40
DX 917042		5420000028807	42	3,3	4	938 gr	-	1	1	107,00
DX 917047		5420000028814	47	4	4	1265 gr	-	1	1	115,00
DX 917062		5420000028821	62	4	6	1711 gr	-	1	1	152,00
DX 917082		5420000028838	82	4	8	2262 gr	-	1	1	195,00
DX 917092		5420000028845	92	4	9	2509 gr	-	1	1	220,00
DX 917102		5420000028852	102	4	10	2862 gr	-	1	1	239,00
DX 917112		5420000025295	112	4	11	3203 gr	-	1	1	268,00
DX 917122		5420000028869	122	4	12	3415 gr	-	1	1	292,00
DX 917132		5420000028876	132	4	12	3781 gr	-	1	1	315,00



TEGELBOREN / FORETS SPECIALE CARRELAGE

CD - W200

PREMIUM CERAMICS



Vacuum
Brazed



Harde materialen: graniet, keramiek, porselein, glas, ...
Matériaux durs: granite, céramique, porcelaine, verre, ...

code			Ø				min.	€
			mm					
DX 895005		5420000027220	5	22 gr	-	1	1	11,80
DX 895006		5420000027237	6	23 gr	-	1	1	11,80
DX 895008		5420000027244	8	25 gr	-	1	1	14,00
DX 895010		5420000027251	10	27 gr	-	1	1	15,60
DX 895012		5420000027268	12	31 gr	-	1	1	16,50
DX 895015		5420000029248	15	35 gr	-	1	1	20,30
DX 895020		5420000029255	20	47 gr	-	1	1	26,60
DX 895025		5420000029262	25	56 gr	-	1	1	33,00
DX 895030		5420000029279	30	66 gr	-	1	1	39,40
DX 895035		5420000029286	35	80 gr	-	1	1	45,70

DIAMOND DRILL KIT Premium Ceramics : Ø 5, 6, 8, 10, 12 mm + GUIDE

DX 895200	koffer/coffre	5420000027275	SET	345 gr	-	1	1	88,30
-----------	---------------	---------------	-----	--------	---	---	---	-------



CD - W200

BASIC CERAMICS



Electro
Plated

Harde materialen: graniet, keramiek, porselein, glas, ...
Matériaux durs: granite, céramique, porcelaine, verre, ...



code							min.	€
DIAMOND DRILL KIT Basic Ceramics : Ø 5, 6, 8, 10, 12 mm + GUIDE								
DX 896395	koffer/coffre	5420000029644	SET	322 gr	-	1	1	35,60

TOEBEHOREN VOOR TEGELBOREN
ACCESSOIRES POUR FORETS SPECIALE CARRELAGE

Ø4 - Ø5 - Ø6 - Ø7	5/32" - 3/16" - 1/4"
Ø8 - Ø10 - Ø12	9/32" - 1/2" - 3/8"
Ø20 - Ø35 mm	5/16" - 3/4" - 13/8"

Universele metalen boorgeleider met zuignap
Guide métallique de forage universel avec ventouse

code							min.	€
DX 894000		5420000065031	Ø 4 → 35 mm	750 gr	12	6	1	28,50

Kan gekoppeld worden aan een waterkoelingsysteem.
 Peut être connecté à un système de refroidissement à eau.

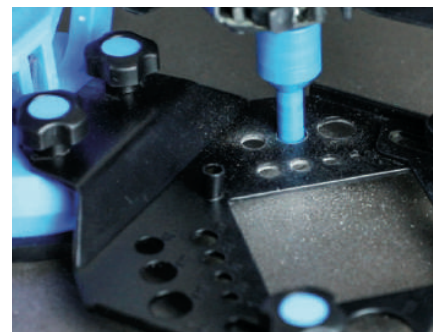
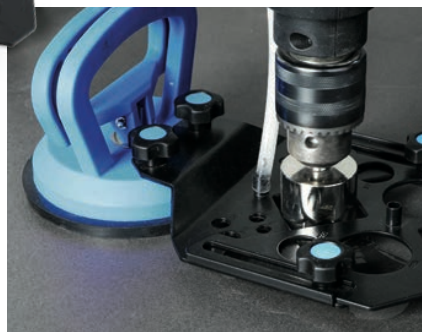
TOEBEHOREN VOOR BOORTECHNIEK
ACCESSOIRES POUR LES TECHNIQUES DE FORAGE
PROFI
4,00 m
Werkdruk • Pression de travail : 3 bar

- Drukreservoir voor water
- Reservoir : polyethyleen
- Afdichting NBR
- Réservoir d'eau sous pression
- Réservoir : polyéthylène
- Joints NBR









DX 982000

FERROX PLUS
2,50 m
Werkdruk • Pression de travail : 6 bar
Draagbaar op de rug • Transport dorsal

- Drukreservoir voor water
- Reservoir : staal / polyester
- Afdichting NBR
- Réservoir d'eau sous pression
- Réservoir : acier / polyester
- Joints NBR

DX 982850

Waterdrukvat voor watertoevoerapparaat
Reservoir à eau sous pression pour dispositif d'approvisionnement en eau









code								min.	€
DX 982000		5420000023178	PROFI	10 L	3424 gr	30	1	1	98,60
DX 982850		5420000023185	FERROX PLUS	10 L	6100 gr	-	1	1	231,00

TOEBEHOREN VOOR BOORTECHNIEK ACCESSOIRES POUR LES TECHNIQUES DE FORAGE

Droogboren Couronnes à sec







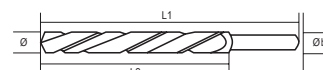

Centreeropname met uitdrijfwig • Porte-outil de centrage avec chasse-cône

code								min.	€
DX 981056		5420000021549	6-kant / 6-pans	M16 (M)	150 gr	-	10	1	16,96
DX 981063		5420000021556	SDS+ aansluiting raccord	M16 (M)	150 gr	-	10	1	20,81



Centreerboor voor centreeropname • Mèche de centrage pour porte-outil de centrage

code			Ø	Ø bis	L1	L2				min.	€
			mm	mm	mm	mm					
DX 981070		5420000021563	8	7	120	70	38 gr	-	10	1	8,90
DX 981071		5420000022607	8	7	250	190	64 gr	-	1	1	23,57

Adapter - verloopstuk • Raccord de réduction

new design

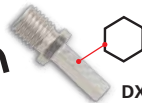











DX 981060



DX 980415











DX 980416

code								min.	€
DX 981060		5420000046832	6-kant / 6-pans	M14 (M)	150 gr	-	1	1	12,80
DX 980415		5420000024809	M18 (F)	M14 (M)	128 gr	-	1	1	56,80
DX 980416		5420000022102	M18 (F)	M16 (M)	179 gr	-	1	1	35,80













System-H stofafzuigunit • System-H carter d'aspiration

code								min.	€
DX 981214		5420000024007	M16 (F)	M16 (M)	383 gr	-	1	1	95,30
DX 981215		5420000024014	M18 (F)	M16 (M)	383 gr	-	1	1	95,30











Dusty stofafzuigunit incl. centreerpen • Carter d'aspiration, axe de centrage incl.

code								min.	€
DX 981200		5420000022317	M16 (F)	M16 (M)	1050 gr	-	1	1	199,00
DX 981201		5420000022324	R 1/2" (M)	M16 (M)	1205 gr	-	1	1	199,00
DX 981203		5420000022614	M18 (F)	M16 (M)	1097 gr	-	1	1	199,00



Centreerpen • Axe de centrage

code			Ø					min.	€
			mm	mm					
DX 981218		5420000033733	8	150	65 gr	-	1	1	33,20
DX 981217		5420000024588	8	230	120 gr	-	1	1	37,05















TOEBEHOREN VOOR BOORTECHNIEK
ACCESSOIRES POUR LES TECHNIQUES DE FORAGE
Natboren
Couronnes à eau
Adapter - verloopstuk • Raccord de réduction

	code								min.	€
	DX 980428		5420000022140	6-kant / 6-pans	R 1/2" (F)	187 gr	-	1	1	41,50
	DX 980429		5420000022157	SDS+ aansluiting / raccord	R 1/2" (F)	175 gr	-	1	1	41,50
	DX 980422		5420000027411	R 1/2" (M)	M16x2 (M)	134 gr	-	1	1	15,90
	DX 980423		5420000022621	R 1/2" (M)	M18 (M)	191 gr	-	1	1	59,10
	DX 980400		5420000021525	R 1/2" (M)	1 1/4" UNC (M)	531 gr	-	1	1	30,45
	DX 980411		5420000021532	1 1/4" UNC (F)	R 1/2" (F)	648 gr	-	1	1	30,45
	DX 980401		5420000027565	R 1/2" (F)	1 1/4" (M)	430 gr	-	1	1	51,90
	DX 980417		5420000022119	M16 (F)	R 1/2" (F)	142 gr	-	1	1	35,50
	DX 980418		5420000022638	M18 (F)	R 1/2" (F)	218 gr	-	1	1	32,05
	DX 980419		5420000022645	M18 (F)	R 1/2" (F) 1 1/4" UNC (M)	369 gr	-	1	1	41,65
	DX 980412		5420000022089	Hilti / Bosch DD-Bi	R 1/2" (F)	312 gr	-	1	1	41,50
	DX 980413		5420000022096	Hilti / Bosch DD-Bi	R 1/2" (F) 1 1/4" UNC (M)	421 gr	-	1	1	53,30

TOEBEHOREN VOOR BOORTECHNIEK ACCESSOIRES POUR LES TECHNIQUES DE FORAGE

Natboren Couronnes à eau

Verlengstukken • Rallonges







code								min.	€
				mm					
DX 985541		5420000022201	R 1/2"	200	895 gr	-	1	1	39,50
DX 985542		5420000022218	R 1/2"	300	1350 gr	-	1	1	51,00
DX 985543		5420000022225	R 1/2"	400	1798 gr	-	1	1	59,30
DX 985546		5420000022232	1 1/4" UNC (M)	200	1996 gr	-	1	1	40,85
DX 985547		5420000022249	1 1/4" UNC (M)	300	3066 gr	-	1	1	51,00
DX 985548		5420000022256	1 1/4" UNC (M)	400	4123 gr	-	1	1	63,20
DX 985549		5420000022263	1 1/4" UNC (M)	500	5000 gr	-	1	1	75,40



1 1/4" UNC



Waterspoelkop • Tête à eau

code								min.	€
DX 980603	vrac	5420000022294	M16 (F)	R 1/2" (F)	830 gr	-	1	1	194,00
DX 980604	vrac	5420000022300	3-kant / 3-pans	R 1/2" (F)	820 gr	-	1	1	104,00



ELETTA STEENZAAG • SCIE À PIERRE

NEW



Inclusief schijf.
Disque inclus.
1 x DX 112351

ELETTA 400

	3Hp / 2,2Kw 9A 230V / 50Hz
	13 A
	2800
	350 mm / 25,4 mm 400 mm / 25,4 mm incl. DX 112351
	800 mm
	405 x 405 mm
	Ø 350 mm : 105 mm Ø 400 mm : 135 mm
	Ø 350 mm : 80 mm Ø 400 mm : 110 mm
	150 mm
	-
	✓
	type PO



WATER DECANTING SYSTEM



ORIGINAL WATER RECYCLING PUMP



DISK'S LUBRICATION



Zaagkop kantelbaar voor verstekzagen van 45° tot 90°.

Tête inclinable pour les découpes d'onglets, de 45° à 90°.



Voorzien van een uitneembaar dienblad voor eenvoudigere reiniging.

Équipé d'un plateau amovible pour un nettoyage plus facile.



Inklapbare poten om het transport op de bouwplaats te vergemakkelijken.

Pieds pliables pour faciliter le transport vers l'endroit sur le chantier.



Kantelbare snijkop voor snellere en preciezere uitvoering van speciale snedes. Kan op de gewenste hoogte worden vergrendeld.

Tête de coupe inclinable pour une exécution plus rapide et plus précise des coupes spéciales. Peut être verrouillée à la hauteur souhaitée.



DRAAGHENGSEL: Voor- en achterhandgreep voor gemakkelijk verplaatsen.

POIGNÉE DE TRANSPORT: Poignées avant et arrière pour un déplacement facile.



code							min.	€
BP 8000		8021410069496	ELETTA 400	65,000 kg	1	-	1	1522,00

ELITE 80 S STEENZAAG • SCIE À PIERRE

ELITE 80 S

	3Hp / 2,2Kw 9A 230V / 50Hz
	13 A
	2800
	350 mm / 25,4 mm incl. DX 290351
	800 mm
	435 x 435 mm
	110 mm
	80 mm
	130 mm
	✓
	✓
	type P2



Inclusief schijf.
Disque inclus.
1 x DX 290351

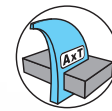

ORIGINAL WATER RECYCLING PUMP



LEG FASTENING SYSTEM



WATER DEGANTING SYSTEM



DISK'S LUBRICATION



Zaagkop kantelbaar voor verstekzagen van 45° tot 90°.
Tête inclinable pour les découpes d'onglets, de 45° à 90°.



Kantelbare slijpkop voor snellere en preciezere uitvoering van speciale snedes. Kan op de gewenste hoogte worden vergrendeld.
Tête de coupe inclinable pour une exécution plus rapide et plus précise des coupes spéciales. Peut être verrouillé à la hauteur souhaitée.

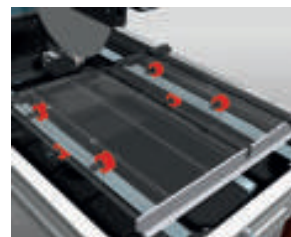

Werktafel met glijdende slede voorzien van 6 verstelbare nylon wielen en 12 kogellagers voor een perfecte precisie, stabiliteit en glijvermogen.
Table de travail avec chariot coulissant équipé de 6 roues en nylon réglables et de 12 roulements à billes pour une précision, une stabilité et un glissement parfait.



BEDIENINGSPANEEL
- Veiligheidsschakelaar met minimumspanningsspoel.
- Stroomonderbreker met manuele reset in geval van vastlopen van de schijf.
- Rood controlelampje voor werking machine.
PANNEAU DE COMMANDE
- Interrupteur de sécurité avec bobine de tension minimale.
- Disjoncteur avec réarmement manuel en cas de blocage du disque.
- Témoin lumineux rouge pour le fonctionnement de la machine.



code						min.	€
BP 9001	8021410090018	ELITE 80 S	73,000 kg	3	1	1	2046,00
Set wielen • Roues en kit							
BP 90102R	8021410044073	-	4,870 kg	-	1	1	88,40
Set zwenkwielen • Kit de roues pivotantes							
BP 90176R	8021410067652	-	7,000 kg	-	1	1	194,00



EXPERT STEENZAAG • SCIE À PIERRE

DIAZO
 www.diazo.com

 Inclusief schijf.
 Disque inclus.

ORIGINAL WATER RECYCLING PUMP

BP 9700

LEG FASTENING SYSTEM



WATER DECANTING SYSTEM



DISK'S LUBRICATION

	EXPERT 400S	EXPERT 500S	EXPERT 600XL	EXPERT 600S XL	EXPERT 700
	3,8Hp / 2,8Kw 12A 230V / 50Hz	4,5Hp / 3,5Kw 16A 230V / 50Hz	4,5Hp / 3,5Kw 16A 230V / 50-60Hz	5,5Hp / 4Kw 8A 400V / 50/60Hz	5,5Hp / 4Kw 8A 400V / 50/60Hz
	16 A	10-16 A	16-20 A	10-16 A	10-16 A
	2800	1400 / 1700	1400 / 1700	1400 / 1700	1400 / 1700
	400 mm / 25,4 mm incl. DX 290401	500 mm / 25,4 mm incl. DX 115501	incl. DX 115601	incl. DX 115601	700 mm / 25,4 mm incl. DX 115701
	570 mm	750 mm	750 mm	750 mm	550 mm
	395 x 395 mm	412 x 412 mm	412 x 412 mm	412 x 412 mm	389 x 389 mm
	135 mm	170 mm	220 mm	220 mm	270 mm
	155 mm	235 mm	285 mm	285 mm	340 mm
	✓	✓	-	✓	-
	✓	✓	✓	✓	✓
	type P2	type P3	type P3	type P3	type P3

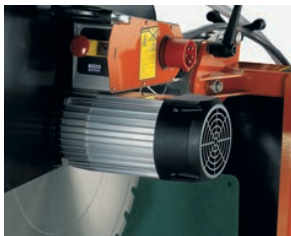
BEDIENINGSPANEEL

- Schakelaar met ontgrendelingsspoel.
- Oververhittingsbeveiliging in geval van vastlopen van de schijf.
- Drukknop om de machine te stoppen.

PANNEAU DE COMMANDE

- Interrupteur avec bobine de déverrouillage.
- Protection contre la surchauffe en cas de blocage du disque.
- Bouton poussoir pour arrêter la machine.

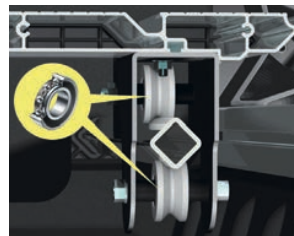

- De werktafel is zeer sterk en stabiel. Hij schuift op 2 stalen vierkante rails met 6 wielen; 4 boven en 2 onder.
- Elk wiel heeft 2 kogellagers voor een totaal van 12.

La table de travail est très solide et stable.

- Elle glisse sur 2 rails carrés en acier avec 6 roues; 4 au dessus et 2 en dessous.
- Chaque roue comporte 2 roulements à billes, soit un total de 12.



- De snijkop is kantelbaar en kan op de gewenste hoogte worden vergrendeld.

La tête de coupe est inclinable et peut être bloquée à la hauteur souhaitée.



- De snijpositie met glijdende slede. La position de coupe avec chariot coulissant.

BP 90102R

BP 90176R

code							min.	€
BP 9401		8021410061346	EXPERT 400S	78,000 kg	3	1	1	2518,00
BP 9501/M		8021410065405	EXPERT 500S	85,000 kg	2	1	1	2974,00
BP 9620/M		8021410067737	EXPERT 600XL	86,000 kg	2	1	1	3252,00
BP 9621		8021410067744	EXPERT 600S XL	86,000 kg	2	1	1	3530,00
BP 9700		8021410044134	EXPERT 700	100,000 kg	2	1	1	3777,00
Set wielen • Roues en kit								
BP 90102R		8021410044073	-	4,870 kg	-	1	1	88,40
Set zwenkwielen • Kit de roues pivotantes								
BP 90176R		8021410067652	-	7,000 kg	-	1	1	194,00

PRIME STEENZAAG • SCIE À PIERRE

	PRIME 100S	PRIME 120S	PRIME 150S	PRIME 200S
	3Hp / 2,2Kw 9A 230V / 50Hz	3Hp / 2,2Kw 9A 230V / 50Hz	3Hp / 2,2Kw 9A 230V / 50Hz	3Hp / 2,2Kw 9A 230V / 50Hz
	13 A	13 A	13 A	13 A
	2800	2800	2800	2800
	350 mm / 25,4 mm incl. DX 330351	350 mm / 25,4 mm incl. DX 330351	350 mm / 25,4 mm incl. DX 330351	350 mm / 25,4 mm incl. DX 330351
	1000 mm	1200 mm	1500 mm	2000 mm
	705 x 705 mm	845 x 845 mm	1060 x 1060 mm	1410 x 1410 mm
	110 mm	110 mm	110 mm	110 mm
	180 mm	180 mm	180 mm	180 mm
	80 mm	80 mm	80 mm	80 mm
	✓	✓	✓	✓
	✓	✓	✓	✓
	type P3	type P3	type P3	type P3



Inclusief schijf.
Disque inclus.
1 x DX 330351



Zaagkop kantelbaar voor verstekzagen van 45° tot 90°.

Tête inclinable pour les découpes d'onglets, de 45° à 90°.

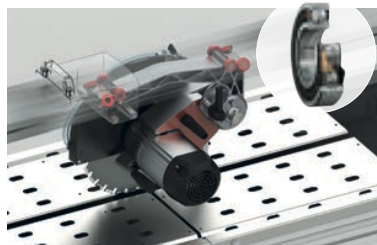

De motorgroepwagen glijdt met 8 kogellagers over verwisselbare roestvrijstalen rails.

Le chariot motorisé glisse sur des rails remplaçables en acier inoxydable avec 8 roulements à billes.



Het snijvoortgangssysteem met handwiel past de beweging van de snijkop naar voren of naar achteren aan.

Le système d'avancement de la coupe avec manivelle permet de régler le mouvement de la tête de coupe vers l'avant ou vers l'arrière.

code							min.	€
BP 91001		8021410023344	PRIME 100S	97,000 kg	3	1	1	2686,00
BP 91201		8021410023771	PRIME 120S	105,000 kg	3	1	1	2864,00
BP 91501		8021410024044	PRIME 150S	127,000 kg	3	1	1	3142,00
BP 92001		8021410054959	PRIME 200S	143,000 kg	3	1	1	3567,00

B-LOCK tegelvergrendelingsysteem • Système de verrouillage des carreaux B-LOCK

BP 90262U		8021410067645	-	1,100 kg	-	1	1	125,00
-----------	--	---------------	---	----------	---	---	---	---------------

Verlengde zijtafel • Table latéral prolongé

BP 90241		8021410022132	60 x 50 cm	8,500 kg	-	1	1	182,00
----------	--	---------------	------------	----------	---	---	---	---------------

Set wielen • Roues en kit

BP 90102R		8021410044073	-	4,870 kg	-	1	1	88,40
-----------	--	---------------	---	----------	---	---	---	--------------

Set zwenkwielen • Kit de roues pivotantes

BP 90176R		8021410067652	-	7,000 kg	-	1	1	194,00
-----------	--	---------------	---	----------	---	---	---	---------------



VIP TEGELZAAG • SCIE POUR CARRELAGE

VIDEO

 Inclusief schijf.
 Disque inclus.

ORIGINAL WATER RECYCLING PUMP



DISK'S LUBRICATION

	VIP 290	VIP 2125
	1,3Hp / 1,0Kw 4,5A 230V / 50Hz	1,8Hp / 1,4Kw 6A 230V / 50Hz
	2800	2800
	200 mm / 25,4 mm incl.	200 mm / 25,4 mm incl.
	900 mm	1250 mm
	635 x 635 mm	880 x 880 mm
	40 mm	40 mm
	40 mm	35 mm
	55 mm	55 mm
	-	-
	-	-
	type P0	type P2/4



Shuko



Shuko



De motorgroepwagen glijdt met 8 kogellagers over verwisselbare roestvrijstalen rails.

Le chariot motorisé glisse sur des rails remplaçables en acier inoxydable avec 8 roulements à billes.



De snijkop is voorzien van een invalzaagsysteem en kan op de gewenste zaagdiepte worden vergrendeld. Hij maakt elke gewenste vorm mogelijk.

La tête de coupe est munie d'un système plongeant et peut être verrouillée à la profondeur voulue. Elle permet de réaliser toutes les formes souhaitées.

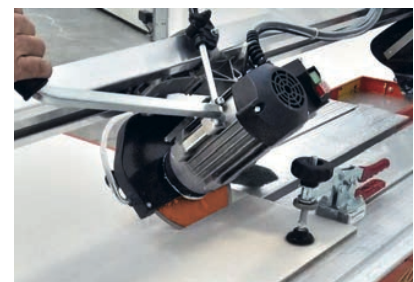

Zaagkop kantelbaar voor verstekzagen van 45° tot 90°.

Tête inclinable pour les découpes d'onglets, de 45° à 90°.



BP 90262U



BP 85015

code							min.	€
BP 855		8021410008556	VIP 290	40,000 kg	8	1	1	1259,00
BP 857		80214100065863	VIP 2125	51,000 kg	4	1	1	1685,00
B-LOCK tegelvergrendelingssysteem • Système de verrouillage des carreaux B-LOCK								
BP 90262U		8021410067645	-	1,100 kg	-	1	1	125,00
Verlengde zijtafel • Table latéral prolongé								
BP 85015		8021410850155	-	7,000 kg	-	1	1	156,00



CLASS S / CLASS PLUS TEGELZAAG • SCIE POUR CARRELAGE

	CLASS 900 S	CLASS PLUS 1050 S	CLASS PLUS 1300 S
	1,3Hp / 1,0Kw 4,5A 230V / 50Hz	1,8Hp / 1,4Kw 6A 230V / 50Hz	1,8Hp / 1,4Kw 6A 230V / 50Hz
	2800	2800	2800
	200 mm / 25,4 mm incl.	250 mm / 25,4 mm incl.	250 mm / 25,4 mm incl.
	900 mm	≤ 42 mm : 1050 mm > 42 mm : 910 mm	≤ 42 mm : 1300 mm > 42 mm : 1160 mm
	635 x 635 mm	≤ 42 mm : 740 x 740 mm > 42 mm : 645 x 645 mm	≤ 42 mm : 920 x 920 mm > 42 mm : 820 x 820 mm
	40 mm	65 mm	65 mm
	40 mm	53 mm	53 mm
	55 mm	80 mm	80 mm
	✓	✓	✓
	✓	✓	✓
	type P0	type P0	type P2/4

Shuko

Shuko

Shuko

Inclusief schijf.
Disque inclus.



De motorgroepwagen glijdt met 8 kogellagers over verwisselbare roestvrijstalen rails.
Le chariot motorisé glisse sur des rails remplaçables en acier inoxydable avec 8 roulements à billes.

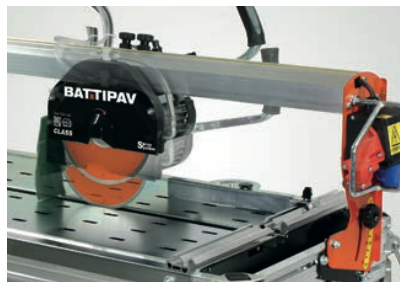

De snijkop is voorzien van een invalzaagsysteem en kan op de gewenste zaagdiepte worden vergrendeld. Hij maakt elke gewenste vorm mogelijk.

La tête de coupe est munie d'un système plongeant et peut être verrouillée à la profondeur voulue. Elle permet de réaliser toutes les formes souhaitées.

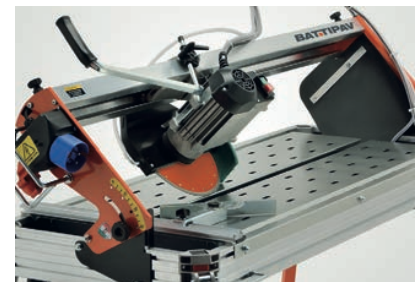

Zaagkop kantelbaar voor verstekzagen van 45° tot 90°.

Tête inclinable pour les découpes d'onglets, de 45° à 90°.

code							min.	€
BP 65901		8021410044646	CLASS 900 S	46,000 kg	3	1	1	1860,00
BP 661101		8021410062329	CLASS PLUS 1050 S	52,000 kg	3	1	1	1987,00
BP 661351		8021410064057	CLASS PLUS 1300 S	58,500 kg	3	1	1	2289,00
B-LOCK tegelvergrendelingsysteem • Système de verrouillage des carreaux B-LOCK								
BP 90262U		8021410067645	-	1,100 kg	-	1	1	125,00
Verlengde zijtafel • Table latéral prolongé								
BP 70241		8021410044684	60 x 50 cm	9,000 kg	-	1	1	187,00
Set wielen • Roues en kit								
BP 70102R		8021410044707	-	4,000 kg	-	1	1	70,70

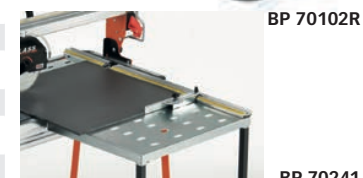

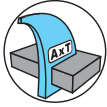
TOEBEHOREN VOOR ELEKTRISCHE TAFELZAAGMACHINES
ACCESSOIRES POUR LES SCIES SUR TABLE ÉLECTRIQUE

ORIGINAL WATER RECYCLING PUMP



	P0	P2	P2/4	P3
Vermogen Puissance	35W	55W	55W	60W
Kabellengte Kabellengte	2,2 m	2,2 m	4 m	2,2 m
Isolatieklasse Classe d'isolation	F	F	F	F
IP	X8	X8	X8	X8
Bereik Gamme	230V-50hz	700 l/h	1000 l/h	1560 l/h
	230V-60hz	700 l/h	950 l/h	1250 l/h

REF.	MACHINE	TYPE
BP 8000	ELETTA 400	P0
BP 9001	ELITE 80	P2
BP 9401	EXPERT 400S	P2
BP 9501/M	EXPERT 500S	P3
BP 9620/M	EXPERT 600XL	P3
BP 9700	EXPERT 700	P3
BP 91001	PRIME 100S	P3
BP 91201	PRIME 120S	P3
BP 91501	PRIME 150S	P3
BP 92001	PRIME 200S	P3
BP 855	VIP 290	P0
BP 857	VIP 2125	P2/4
BP 65901	CLASS 900	P0
BP 661101	CLASS PLUS 1050	P0
BP 661351	CLASS PLUS 1300	P2/4

Waterpomp • Pompes à eau

code							min.	€
BP P0		542000066557	P0	0,990 kg	-	1	1	82,20
BP P2		8021410029735	P2	1,130 kg	-	1	1	71,20
BP P2/4		8021410029742	P2/4	1,150 kg	-	1	1	89,30
BP P3		8021410030076	P3	1,416 kg	-	1	1	80,10

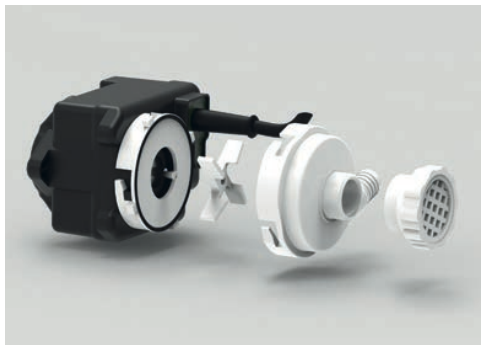
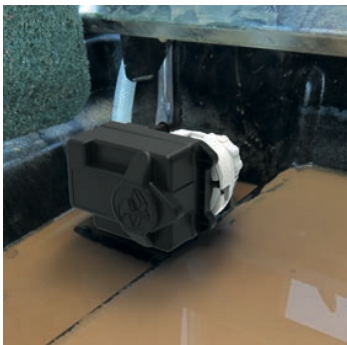
TOEBEHOREN VOOR WATERPOMP
ACCESSOIRES POUR LES POMPES À EAU
Aanzuigset (compleet mondstuk voor P0 + turbine + O-ring)
Kit d'aspiration (buse complète pour P0 + turbine + joint torique)
BP SPS003 8021410054034 voor/pour P0/P1 0,100 kg - 1 1 **6,42**
Aanzuigset (compleet mondstuk voor P2/P3 + turbine)
Kit d'aspiration (buse complète pour P2/P3 + turbine)
BP SPS203 8021410054041 voor/pour P2/P3 0,100 kg - 1 1 **8,69**

BP SPS203