

1

Made
in
Germany

EIBENSTOCK

MENGMACHINES
MENGSTANGEN
HANDBOORMACHINES
DIAMANTBOORMACHINES
BOORSTATIEVEN
WANDSCHUURMACHINES
POLIJSTMACHINES
SCHUURMACHINES
BETONSLIJERS
RENOVATIEFREESMACHINES
BUISSNIJDER
DIAMANTZAGEN
HAAKSE SLIJERS
SLEUVENZAAGMACHINES
ZAAGMACHINE MET DUBBEL BLAD
WATERRECYCLINGSYSTEEM
WATERAFVOERPOMP
INDUSTRIËLE ZUIGERS

MACHINES À MALAXER
MALAXEURS
PERCEUSES À MAIN
MACHINES DE FORAGE DIAMANT
BÂTIS DE FORAGE
PONCEUSES MURALES ÉLECTRIQUES
POLISSEUSES ÉLECTRIQUES
PONCEUSES
PONCEUSES À BÉTON
FRAISEUSES DE RÉNOVATION
SCIE À TUYAU
SCIES DIAMANTÉES
MEULEUSES D'ANGLE
RAINUREUSES
DÉCOUPEUSE À LAME DOUBLE
SYSTÈME DE RECYCLAGE D'EAU
POMPE D'ÉVACUATION D'EAU
ASPIRATEURS INDUSTRIELS



EIBENSTOCK
Power Tools



www.eibenstock.com

SYMBOLIEK / SYMBOLIQUE

	Vermogen Puissance		Kabellengte Longueur de câble		Gewicht Poids		Toerental Tour par minute		Compatibel met stofzuiger Compatible avec aspirateur
--	------------------------------	--	---	--	-------------------------	--	-------------------------------------	--	--

Mengstangen • Malaxeurs

	Aansluiting Raccord		Maximale capaciteit Capacité maximale		Max. Ø		Incl. mengstang Mélangeur incl.		incl. speciale mengstang Mélangeur spécial incl.
	Verven, primers, lakken Peintures, primers, laques		Kant- en klaremortel Mortier-colle, ciment		Tegellijmen Colles carrelage		Gips, voegspecie, crépi Plâtre, enduit, crépi		Epoxyharsen, bitumencoatings Résine epoxy, revêtements de bitumes

Boor- en schroefmachines • Perceuses et visseuses

	Gereedschaphouder Porte-outils		Spanflens Bride de serrage		Onbelaste draaisnelheid Vitesse de rotation à vide		Nominale draaisnelheid Vitesse de rotation nominale		Max. boordiameter Diamètre de forage max.
	Rechts- en linksdraaiend Rotation bi-directionnelle								

Diamantboortechnieken • Techniques de forage diamanté

	Nominale draaisnelheid Vitesse de rotation nominale		Aansluiting Raccord		Gereedschaphouder Porte-outils		Kabel in Polyurethaan Cable en Polyuréthane		Max. Ø in gewapend beton met boorstatief Ø max. dans le béton armé avec dati de forage
	Nominale draaisnelheid in beton Vitesse de rotation nominale dans le béton		Nominale draaisnelheid in baksteen Vitesse de rotation nominale dans la brique		Max. Ø in baksteen met droog gebruik Ø max. dans la brique avec utilisation à sec		Max. Ø in gewapend beton met droog en nat gebruik Ø max. dans le béton armé utilisation à sec et à eau		

Boorstatieven • Bâts de forage

	Max. Ø aan 90° Ø max. à 90°		Kolomlengte Longueur de colonne		Spanhals Collier de serrage		Max. helling Inclinaison max.		Voetafmetingen Dimension du pied
	Vacuüm Sous vide		Aansluiting machine / statief Raccord machine / bâti		Aansluiting machine / statief Raccord machine / bâti				

Schuur-, polijst- en zaagmachines • Machines à poncer, à polir et à couper



	Max. Ø Ø max.		Nominale draaisnelheid Vitesse de rotation nominale		Gereedschaphouder Porte-outils		Onbelaste draaisnelheid Vitesse de rotation à vide		Nominale draaisnelheid Vitesse de rotation nominale
	Max. snijlengte Longueur de coupe max.		Max. snijlengte Longueur de coupe max.		Max. snijdikte Épaisseur de coupe max.		Onbelaste draaisnelheid Vitesse de rotation à vide		Nominale draaisnelheid Vitesse de rotation nominale
	Zaagbladlengte Longueur de la lame		Aantal slagen per min. Nombre de coups par min.		Accu type Type de batterie				

Industriële stofzuigers • Aspirateurs industriel





	Max. capaciteit - stof Capacité max. - poussière		Max. capaciteit - nat Capacité max. - eau		Max. zuigkracht Aspiration max.		Filteroppervlakte Surface du filtre		Afmetingen van stofzuiger Dimensions de l'aspirateur
--	--	--	---	--	---	--	---	--	--

BASIC LINE

NEW

	EE 07117 MXT 1300	EE 07118 MXT 1300/2
	1300W 230V	1300W 230V
	0 - 1000 min ⁻¹	0 - 400 min ⁻¹ 0 - 730 min ⁻¹
	3 m H07RN-F	3 m H07RN-F
	M14	M14
	40 kg	50 kg
	140 mm	140 mm
	4 kg	4,5 kg
	Ø 140 mm	Ø 140 mm





code							min.	€
EE 07117		4026851019370	1300 Watt	4,000 kg	20	1	1	149,00
EE 07118		4026851019387	1300 Watt	4,500 kg	20	1	1	191,00

PRO LINE

EE 077E5

EHR 15.2 SB

	1050W 230V
	0 - 450 / min RPM
	3 m H07RN-F
	M14
	40 kg MAX
	120 mm MAX
	3,1 kg
	Ø 120 mm EE 31224



EHR 15.2 SB

EE 07779P

EHM 162 S

	2000W 230V
	0 - 430 / min
	3 m H07BQ-F
	M14
	80 kg
	180 mm
	7,2 kg
	Ø 160 mm EE 31327

EE 10070

EHM 162 S

	2000W 230V
	0 - 430 / min
	3 m H07BQ-F
	M14
	80 kg
	180 mm
	7,2 kg
	Ø 180 mm FC 073428

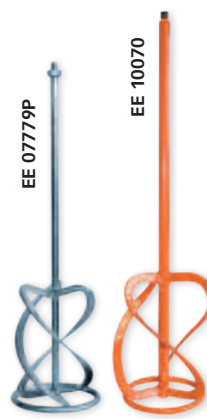







Kabel/Cable
PUR

EE 07779P

EE 10070

EHM 162 S



code							min.	€
EE 077E5		4026851017413	1050 Watt	5,880 kg	40	1	1	285,00
EE 07779P		4026851012340	2000 Watt	8,460 kg	40	1	1	431,00
EE 10070		4026851012708	2000 Watt	8,560 kg	30	1	1	434,00

PRO LINE

EE 077E2 EHR 20/2.6 S		EE 077E3 EHR 23/2.5 S		EE 10060 EHR 23/2.5 S		EE 0774W EZR 24 R R/L	
	1300W 230V		1800W 230V		1800W 230V		1800W 230V
	0 - 250 / min 0 - 450 / min		0 - 250 / min 0 - 580 / min		0 - 250 / min 0 - 580 / min		180 - 440 / min
	3 m H07BQ-F		3 m H07BQ-F		3 m H07BQ-F		3 m H07BQ-F
	M14		M14		M14		Special
	50 kg		80 kg		80 kg		80 kg
	150 mm		180 mm		180 mm		230 mm
	5,1 kg		6,9 kg		6,9 kg		11,7 kg
	Ø 140 mm EE 31326		Ø 160 mm EE 31327		Ø 180 mm FC 073428		Ø 230 mm EE 31630

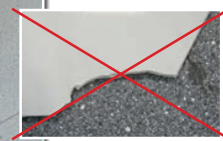
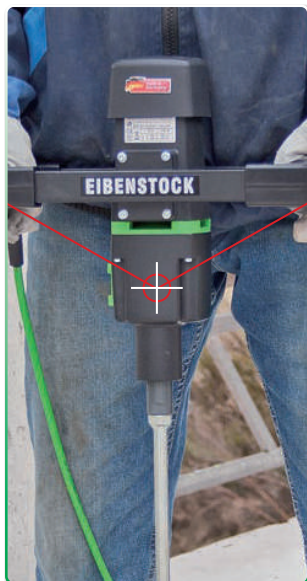

code							min.	€
EE 077E2		4026851016218	1300 Watt	8,360 kg	15	1	1	458,00
EE 077E3		4026851016263	1800 Watt	10,480 kg	20	1	1	520,00
EE 10060		5420000032231	1800 Watt	10,580 kg	30	1	1	546,00
EE 0774W		4026851018441	1800 Watt	14,820 kg	-	1	1	746,00

EE 07614
AUTOMIX 1801

	1500W 230V
	50 min ⁻¹
	3 m H07RN-F
	M20
	65 L 50 kg
	26,5 kg
	EE 31440

EE 07623
TWINMIX 1800T

	1800W 230V
a	250/450 min ⁻¹
b	20/36 min ⁻¹
	3 m H07RN-F
	M14 / Special
	65 L 50 kg
	70,0 kg
	a & b

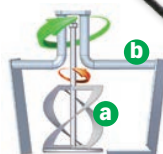

EE 32341

code						min.	€
EE 07614	4026851008206	1500 Watt	28,500 kg	4	1	1	979,00
EE 07623	4026851016119	1800 Watt	74,000 kg	-	1	1	2605,00
Mengstang voor AUTOMIX 1801 • Malaxeur pour AUTOMIX 1801							
EE 31440	4026851006066	M20	2,170 kg	-	1	1	112,00
Kuip voor AUTOMIX 1801 / TWINMIX 1800T • Cuvelle pour AUTOMIX 1801 / TWINMIX 1800T							
EE 32341	4026851006080	65 L - 57,5 X 34 cm	2,100 kg	-	1	1	17,80

EE 07625
FLOORMIX 2300

	2300W 230V
	70/130/160/280 min ⁻¹
	0,20 m H07RN-F
	M16
	110 L 150 kg
	48,0 kg
	compatibel



- Voor egalisiemortels
Pour mortiers d'égalisation















code						min.	€
EE 07625	4026851016034	2300 Watt	52,000 kg	-	1	1	2032,00



Mengstang type R/RG - speciaal voor dunne, vloeibare materialen (verven, lakken, primers)

Malaxeur type R/RG - idéal pour matériaux liquides et peu consistants (peintures, vernis, primers)

















code			Schacht Tige 	Ø mm	↔ mm	 kg				min.	€
Hexagonaal • Hexagonale											
EE 31111	vrac	4026851001719	 8	70	400	10	0,262 kg	-	1	1	7,50
EE 31112	vrac	4026851001726	 8	85	400	15	0,264 kg	-	1	1	9,50
EE 31113	vrac	4026851001733	 10	100	600	20	0,623 kg	-	1	1	11,80
EE 31114	vrac	4026851001740	 10	120	600	25	0,699 kg	-	1	1	14,20
M14 • M14											
EE 31124	vrac	4026851001764	 14	120	600	25	1,042 kg	-	1	1	18,90



Mengstang type W/WG - speciaal voor kleverige en dikvloeibare materialen (tegellijmen, kant - en klaarmortel, voegspecie)

Malaxeur type W/WG - idéal pour matériaux collants et pâteux (colle carrelage, mortier-colle, enduit, ciment)











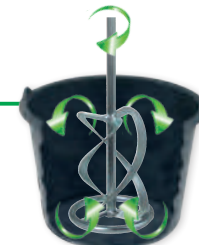





code			Schacht Tige 	Ø mm	↔ mm	 kg				min.	€
Hexagonaal • Hexagonale											
EE 31212	vrac	4026851001788	 8	85	400	8	0,320 kg	-	1	1	10,00
EE 31214	vrac	4026851001801	 10	120	600	20	0,849 kg	-	1	1	21,30
M14 • M14											
EE 31224	vrac	4026851001856	 14	120	600	20	1,167 kg	-	1	1	23,70
EE 31225	vrac	4026851001818	 14	135	600	50	1,274 kg	-	1	1	27,30
EE 31227	vrac	4026851001870	 14	160	600	80	1,622 kg	-	1	1	34,80



Mengstang type M/MG - speciaal voor zware en dikvloeibare materialen (gipsen, pleisters, mortel, spachtels)

Malaxeur type M/MG - idéal pour matériaux lourds et crémeux (plâtres, mortiers, crépi)



code			Schacht Tige 	Ø mm	↔ mm	 kg				min.	€
Hexagonaal • Hexagonale											
EE 31314	vrac	4026851001887	 12	120	600	25	1,004 kg	-	1	1	23,70
M14 • M14											
EE 31324	vrac	4026851001917	 14	120	600	25	1,150 kg	-	1	1	26,00
EE 31326	vrac	4026851001924	 14	140	600	50	1,292 kg	-	1	1	30,90
EE 31327	vrac	4026851001931	 14	160	600	80	1,705 kg	-	1	1	36,00
EE 31328	vrac	4026851010896	 14	180	600	80	1,630 kg	-	1	1	45,50



Mengstang type SGR - speciaal voor vloeibare en vloeïende materialen (dunbedmortel, vulmiddelen, nivelleermassa's, coatings en kleefstoffen)
Malaxeur type SGR - idéal pour matériaux liquides et coulants (mortiers-collés, enduits, produits de nivellement, revêtements et adhésifs)



code			Schacht Tige	Ø mm	mm	kg			min.	€	
M14 • M14											
EE 31528	vrac	4026851018731		150	595	50	1,630 kg	-	1	1	54,70



Mengstang type LG - speciaal voor kleverige en vloeibare materialen (lijmen, epoxyharsen, bitumencoatings, gietmassa)
Malaxeur type LG - idéal pour matériaux collants et coulants (colles et joints, revêtements de bitumes, résine époxy)



code			Schacht Tige	Ø mm	mm	kg			min.	€	
M14 • M14											
EE 31024	vrac	4026851004567		120	600	25	0,870 kg	-	1	1	16,60

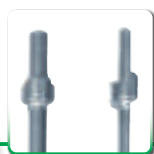

Mengstang voor EZR 24 R R/L - EZR 23 R R/L - speciaal voor kleverige en vloeibare materialen (lijmen, epoxyharsen, bitumencoatings, gietmassa)
Malaxeur pour EZR 24 R R/L - EZR 23 R R/L - idéal pour matériaux collants et coulants (colles et joints, revêtements de bitumes, résine époxy)

EE 31620

EE 31610

EE 31630

code			Schacht Tige	Ø mm	mm	kg			min.	€	
EE 31620	vrac	4026851010209		195	650	40	3,650 kg	-	1	1	116,00
EE 31610	vrac	4026851003096		210	650	60	3,850 kg	-	1	1	116,00
EE 31630	vrac	4026851015525		230	650	80	4,050 kg	-	1	1	116,00

Prijs per paar • Prix par paire



Mengstang type RPG - speciaal voor zware materialen (bitumen, leem, afdichtingsmaterialen)
Malaxeur type RPG - idéal pour les matériaux lourds (masses bitumeuses, mastics à sol)



code			Schacht Tige	Ø mm	mm	kg			min.	€	
M14 • M14											
EE 31437	vrac	4026851003294		160	600	50	1,250 kg	-	1	1	17,60

Zie ook
Voir aussi **p.504 & p.505 PINGUIN**

Snelwisseladapter • Adaptateur à connexion rapide

code							min.	€
EE 32143	zakje/sachet	4026851010933	M14 - M14i	0,512 kg	-	1	1	57,90
EE 32144	zakje/sachet	4026851019400	-	0,120 kg	-	1	1	20,60
EE 32145		4026851011602	EE 32143 + EE 32144	0,654 kg	-	1	1	72,70

**KOP • TÊTE
EIBENSTOCK**
M14 - M14
**AANSLUITING M14 x 2
RACCORD M14 x 2**

TYPE MG - WG - LG - RG
Adapters voor mengmachine • Adaptateurs pour malaxeur

code							min.	€
EE 32153		4026851002181	M14i - M14i	0,110 kg	-	1	1	14,20
EE 32173		4026851002198	M18i - M14i	0,120 kg	-	1	1	14,20
EE 32134		4026851010186	raccord SDS ⁺ aansluiting - M14i	0,088 kg	-	1	1	25,60

EE 32173

EE 32134
**KOP • TÊTE
FESTOOL**
**EE 32153
M14i - M14i**

**KOP • TÊTE
FLEX**
**EE 32173
M18i - M14i**

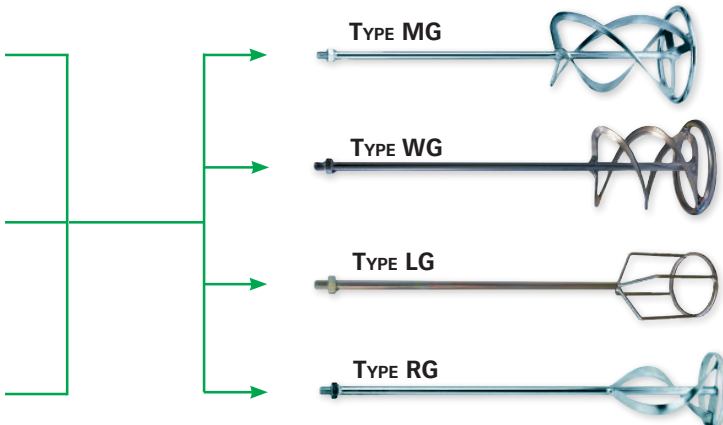
**KOP • TÊTE
Raccord SDS aansluiting**
**EE 32134
SDS⁺ - M14i
Aansluiting
Raccord**

EIBENSTOCK

HANDBOORMACHINES - MACHINES EN TOEBEHOREN
PERCEUSES À MAIN - MACHINES ET ACCESSOIRES



EIBENSTOCK
Power Tools

	EE 0122R EHB 16/2.5 S R/L	EE 0152H EHB 32/2.2 R-R/L	EE 0154A EHB 32/4.2
	1400W	1800W	1700W
	5/8" x 16 UN	MK3	MK3
	43 mm	65 mm	65 mm
	1: 650 / min 2: 1200 / min	1: 60-140 / min 2: 200-470 / min	1: 215 / min 2: 330 / min 3: 460 / min 4: 680 / min
	0 - 400 / min 0 - 750 / min	1: 60-140 / min 2: 200-470 / min	1: 110 / min 2: 175 / min 3: 245 / min 4: 385 / min
	65 mm (Wood) 28 mm (Alu) 20 mm (Steel)	100 mm (Wood) 60 mm (Alu) 32 mm (Steel)	100 mm (Wood) 60 mm (Alu) 32 mm (Steel)
	3 m H07RN-F	3 m H07RN-F	3 m H07RN-F
	4,5 kg	6,4 kg	6,9 kg



EHB 16/2.5 S R/L



EHB 32/2.2 R-R/L



EHB 32/4.2



code						min.	€
EE 0122R	4026851018694	1400 Watt	6,750 kg	-	1	1	460,00
EE 0152H	4026851002570	1800 Watt	8,460 kg	-	1	1	723,00
EE 0154A	4026851002549	1700 Watt	8,900 kg	-	1	1	578,00



Toebehoren voor handboormachines Accessoires pour perceuses à main

code						min.	€
EE 09507	4026851015228	Magnetische boorhouder - B32.1 • Support magnétique pour perceuse - B32.1	17,000 kg	-	1	1	978,00

NEW

	EE 03E11 EHD 1500	EE 0331U EHD 1801	EE 03E28 EHD 2002 S
	1500W 230V	1800W 230V	1800W 230V
	3700 min⁻¹	0-800 min⁻¹	1 : 1500 min⁻¹ 2 : 3000 min⁻¹
	0-2000 min⁻¹	0-550 min⁻¹	1 : 0-850 min⁻¹ 2 : 0-1700 min⁻¹
	32 - 82 mm	132 - 250 mm	1 : Max Ø132mm 2 : Max Ø82mm
	M18	M18	M18
	46 mm	53 mm	53 mm
	3 m H07BQ-F	3 m H07BQ-F	3 m H07BQ-F
	3,9 kg	5,4 kg	5,9 kg

**Kabel / Cable
PUR**

- Mechanische veiligheidskoppeling.
Embrayage de sécurité mécanique.
- Verstelbare handgreep.
Poignée ajustable.
- Elektronische overbelastings beveiliging en temperatuurcontrole, zachte aanloop.
Protection électronique de surcharge et contrôle de la température démarrage progressif.

EE 03E11
EHD 1500
LED indicator
Vervang de koolborstels -
Service-LED lampje brandt
±10 uur voor uitvallen.

Indicateur LED
Remplacer les charbons -
Service LED s'allume
±10 heures avant l'arrêt.

EE 0331U
EHD 1801

NEW

 Bruikbaar met EE 09655 zie blz. 21
Utilisable avec EE 09655, voir p. 21.

EE 03E28
EHD 2002 S

 Bruikbaar met EE 09655 zie blz. 21
Utilisable avec EE 09655, voir p. 21.

code							min.	€
EE 03E11	koffer/coffre	4026851016157	1500 Watt	7,540 kg	-	1	1	488,00
EE 0331U	koffer/coffre	4026851009012	1800 Watt	5,400 kg	-	1	1	604,00
EE 03E28	koffer/coffre	4026851019226	1800 Watt	9,600 kg	-	1	1	726,00

EE 03217
ESD 1801

	1800W 230V
	3000 min ⁻¹ R P M
	0-2050 min ⁻¹ R P M
	92 mm MAX Ø
	M18
	53 mm
	3 m H07RN-F
	5,9 kg



- Transmissie met schakelbare zachte slagen.
Transmission à percussion douce commutable.
- Hoge werksnelheid.
Grande vitesse de travail.
- Mechanische veiligheidskoppeling.
Embrayage de sécurité mécanique.
- Verstelbare handgreep.
Poignée ajustable.
- Elektronische overbelastingsbeveiliging en temperatuurcontrole, zachte aanloop.
Protection électronique de surcharge et contrôle de la température, démarrage progressif.
- Lock-on knop met bescherming tegen onopzettelijke vergrendeling.
Bouton de verrouillage avec protection contre le blocage involontaire.



code						min.	€
EE 03217	koffer/coffre	4026851009241	1800 Watt	12,340 kg	-	1	656,00
Stofafzuigingsunit H-SYSTEM • Système anti poussière H-SYSTEM							
DX 981215		542000024014	M18(F) - M16(M)	0,383 kg	-	1	95,30



code						min.	€
Ø mm							
Diamantdroogboor M16 voor ESD 1801 • Couronne à sec diamanté M16 pour ESD 1801							
EE 36S051	vrac	4026851012128	51	7	0,300 kg	1	167,00
EE 36S067	vrac	4026851012135	67	10	0,500 kg	1	189,00
EE 36S081	vrac	4026851012142	81	11	0,700 kg	1	210,00
Centreerpin voor ESD 1801 • Tige de centrage pour ESD 1801							
DX 981217		5420000024588	230	-	0,120 kg	1	37,05





Baksteen, zachte materialen
Brique et matériau tendre

Beton, gewapend beton
Béton et béton armé

DUST PROTECTION SYSTEM
Mineral dust may cause cancer!



EE 03E25
ESD 162

	2200W 230V
	1100 min⁻¹
	82 - 162 mm
	Max ø 202 mm
	22000 / min
	1/2" + 5/4" UNC
	60 mm
	5 m H07BQ-F PUR
	compatibel
	6,6 kg



EE 03E25

BOORDIAMETER TOT
DIAMÈTRE DE FORAGE JUSQU'À
162 mm*!

* In licht gewapend beton - Dans le béton armé léger

TOEBEHOREN • ACCESSOIRES

2 x montagesleutels / 1 x koffer
2 x clés de montage / 1 x coffre

Stofzuigsysteem
Système d'aspiration



SOFT-IMPACT knop
Bouton SOFT-IMPACT



Te gebruiken met het boorstatief
BST 162H - SPECIAL IMPACT
(EE 0963W - zie pagina 20)
A utiliser avec le bâti de forage
BST 162H - SPECIAL IMPACT
(EE 0963W - voir page 20)



SPECIAL
IMPACT
MACHINE

Boorkroon
niet inbegrepen
Couronne
non-incluse

EE 03SI26-SET

SET : ESD 162 + BST 162H

EE 03SI25-BOX

SET : ESD 162 +
boorkronen/couronnes
CD-DI 835
Ø 82 - 112 - 132 mm

L = 305 mm - 1 1/4"
Ø 82 - 112 - 132 mm



code							min.	€
EE 03E25	koffer/coffre	4026851018564	2200 Watt	11,820 kg	24	1	1	989,00
EE 03SI26-SET		5420000066816	SET: ESD 162 + BST 162H	30,100 kg	-	1	1	1864,00
EE 03SI25-BOX	koffer/coffre	5420000066809	Machine + 3 boorkronen/couronnes	27,080 kg	-	1	1	1730,00



DUST PROTECTION SYSTEM
Mineral dust may cause cancer!



EE 0352W ESD 200

	2500W 230V
	1: 750 min⁻¹ 2: 1500 min⁻¹
	1: 500 min⁻¹ 2: 1050 min⁻¹
	51 - 250 mm
	5/4" UNC
	5 m H07BQ-F PUR
	compatibel
	8,9 kg



Stofzuigsysteem Système d'aspiration



Wateraansluiting Raccord pour eau



!
Bij droog boren met **SOFT-IMPACT** zijn **SOFT-IMPACT-boorkronen** nodig!
Lors du perçage à sec avec **SOFT-IMPACT**, des couronnes de perçage **SOFT-IMPACT** sont nécessaires !

INCLUSIEF TOEBEHOREN • ACCESSOIRES INCLUS
2 Sleutels / Aansluiting voor stofzuiger / water
2 Clés de montage / Raccord pour aspirateur / eau



EE DSE200 DSE 200

SET :
ESD 200 + BST 250

Boorkroon niet inbegrepen
Couronne non-incluse

code							min.	€
EE 0352W		4026851020673	2300 Watt	12,000 kg	-	1	1	1200,00
EE DSE200		5420000073869	SET: ESD 200 + BST 250	26,900 kg	-	1	1	2050,00

SOFT-IMPACT - Diamant droogboorkroon SOFT-IMPACT - Couronne diamanté à sec

code			Ø	#				min.	€
			mm						
DX 835032	vrac	5420000069961	32	5	0,560 kg	-	1	1	110,00
DX 835042	vrac	5420000069978	42	5	0,770 kg	-	1	1	110,00
DX 835052	vrac	5420000069985	52	5	1,000 kg	-	1	1	115,00
DX 835062	vrac	5420000069992	62	5	1,230 kg	-	1	1	131,00
DX 835072	vrac	5420000070004	72	6	1,480 kg	-	1	1	141,00
DX 835076	vrac	5420000070127	76	6	1,640 kg	-	1	1	143,00
DX 835082	vrac	5420000070011	82	6	1,800 kg	-	1	1	146,00
DX 835092	vrac	5420000070028	92	6	2,010 kg	-	1	1	156,00
DX 835102	vrac	5420000070035	102	7	2,310 kg	-	1	1	161,00
DX 835112	vrac	5420000070042	112	7	2,610 kg	-	1	1	166,00
DX 835122	vrac	5420000070059	122	8	2,930 kg	-	1	1	184,00
DX 835132	vrac	5420000070066	132	8	3,260 kg	-	1	1	200,00
DX 835142	vrac	5420000070073	142	8	3,610 kg	-	1	1	273,00
DX 835152	vrac	5420000070080	152	8	4,530 kg	-	1	1	296,00
DX 835162	vrac	5420000070097	162	9	4,950 kg	-	1	1	328,00
DX 835182	vrac	5420000070110	182	9	5,910 kg	-	1	1	389,00

CD-DI 835



Gebruik met
IHT soft impact
boorkroonmachine
+ statief

Utilisation avec
carotteuse et trépied
soft impact IHT





EE 0312C
EFB 125 P

	1150W 230V
	250 - 1000 min ⁻¹
	6 - 125 mm
	G1/2"i
	53 mm
	3 m H07BQ-F PUR
	3,6 kg



Boorkroon
niet inbegrepen
Couronne
non-incluse



INCLUSIEF TOEBEHOREN
ACCESSOIRES INCLUS

1 Sleutel
1 Clé de montage

EE 0312D
EFB 125 P SET

SET :
EFB 125 P
+
BST 125 V

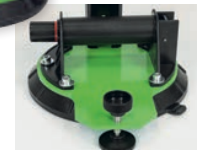

Vacuumpomp incl.
Pompe à vide incl.

code							min.	€
EE 0312C	koffer/coffre	4026851019974	1150 Watt	7,950 kg	-	1	1	560,00
EE 0312D		4026851020383	SET: EFB 125 P + BST 125 V	9,500 kg	-	1	1	940,00
EE 03114	koffer/coffre	4026851011329	1500 Watt	11,740 kg	-	1	1	598,00

EE 03114
END 1550 P

	1500W 230V
	1800 - 4400 min ⁻¹
	6 - 68 mm
	G1/2"i
	53 mm
	3 m H07RN-F
	3,6 kg



- Elektronische overbelastingsbeveiliging en temperatuurcontrole, zachte aanloop.
Protection électronique de surcharge et contrôle de la température démarrage progressif.
- As in roestvrijstaal.
Axe en acier inoxydable.
- Traploze watervoorziening.
Réglage en continu de l'arrivée d'eau.
- Quick change systeem.
Système de changement rapide.

INCLUSIEF TOEBEHOREN
ACCESSOIRES INCLUS

Snelwisseladapter G¹/₂"a / G¹/₂"i + adaptateur G¹/₂" / M12x1,5 a
Adaptateur à changement rapide G¹/₂"a / G¹/₂"i
+ adaptateur G¹/₂" / M12x1,5 a



Boorkronen
Couronnes **PRODIAXO CD W-600** Zie/Voir **p.80**



EE 03E31 ETN 162/3

	2200W 230V
	1: 0 - 510 min ⁻¹ 2: 0 - 1150 min ⁻¹ 3: 0 - 2500 min ⁻¹
	1: 0 - 510 min ⁻¹ 2: 0 - 1150 min ⁻¹ 3: 0 - 2500 min ⁻¹
	1: 122 - 202 mm 2: 62 - 122 mm 3: 12 - 62 mm
	1: 82 - 162 mm 2: 42 - 82 mm 3: 12 - 42 mm
	5/4" UNC + 1/2"
	60 mm
	5 m H07BQ-F PUR
	6,7 kg



EE 03E31



INCLUSIEF TOEBEHOREN ACCESSOIRES INCLUS

2 Sleutels / Aansluiting
voor stofzuiger / water
2 Clés de montage / Raccord
pour aspirateur / eau



LED indicator
Vervang de koolborstels -
Service-LED lampje brandt
ongeveer 10 uur voor uitvallen.
Indicateur LED
Remplacer les charbons
Service LED s'allume environ
10 heures avant l'arrêt.



Afmetingen Dimensions	EE 03E35-SET
A	1050
B	700
C	130
D Profiel/Profile	46 x 60
E	330
F	250
G	510

EE 03E35SET



Boorkroon niet inbegrepen
Couronne non-incluse



EE 03G34-SET

L = 450 mm - 5/4"
Ø 62 - 82 - 112 mm

L = 400 mm - 1/2"
Ø 30 - 40 mm

code							min.	€
EE 03E31	koffer/coffre	4026851012883	2200 Watt	12,700 kg	32	1	1	1147,00
EE 03G34-SET	koffer/coffre	5420000061668	Machine + diamant boorkronen couronnes diamantées Ø 112 - 82 - 62 - 40 - 30 mm + Toebehoren / Accessoires	30,840 kg	15	1	1	1815,00
EE 03E35-SET	koffer/coffre	5420000034105	SET: ETN 162/3 + BST 182 V/S	29,700 kg	-	1	1	2038,00
Vacuüm set • Set Vacuüm								
EE 3585F	zak/sac	4026851013323	Voor / Pour BST 182V/S	0,433 kg	-	1	1	185,00



PowerLine

EE 0343X
PLD 182.1 NT

	2300W 230V
	1: 520 min ⁻¹ 2: 1200 min ⁻¹ 3: 2500 min ⁻¹
	1: 122 - 202 mm 2: 62 - 122 mm 3: 12 - 62 mm
	1: 82 - 182 mm 2: 42 - 82 mm 3: 12 - 42 mm
	G1/2"i + 5/4" UNC
	60 mm
	5 m H07BQ-F PUR
	7,5 kg



INCLUSIEF TOEBEHOREN
ACCESSOIRES INCLUS

2 Sleutels
2 Clés de montage



EE 0343S
PLE 182

SET :
PLD 182.1 NT
+
BST 182 V/S 60/P



**"DE KRACHTIGE COMBINATIE
VOOR BORINGEN TOT Ø 202 MM"**
**"LA COMBINAISON PUISSANTE
POUR FORAGES JUSQU'AU Ø 202 MM"**

Boorkroon
niet inbegrepen
Couronne
non-incluse

code							min.	€
EE 0343X	koffer/coffre	4026851017802	2300 Watt	13,000 kg	-	1	1	1326,00
EE 0343S		4026851015679	SET: PLD 182.1 NT + BST 182 V/S 60/P	30,500 kg	-	1	1	2110,00
Vacuüm set • Set Vacuüm								
EE 3585F	zak/sac	4026851013323	Voor / Pour BST 182 V/S	0,433 kg	-	1	1	185,00



	EE 0352H EBM 250/2 RP	EE 03641 EBM 352/3
	2500W 230V	3000W 230V
	•	•
	1: 360 min ⁻¹ 2: 850 min ⁻¹	1: 230 min ⁻¹ 2: 500 min ⁻¹ 3: 1030 min ⁻¹
	52 - 252 mm	42 - 352 mm
	5/4" UNC	5/4" UNC
	5 m H07BQ-F	5 m H07BQ-F
	10,5 kg	12,5 kg

Kabel / Cable
PUR



LED indicator
Vervang de koolborstels -
Service-LED lampje brandt
ongeveer 10 uur voor
uitvallen.
Indicateur LED
Remplacer les charbons
Service LED s'allume envi-
ron 10 heures avant l'arrêt.



INCLUSIEF TOEBEHOREN
ACCESSOIRES INCLUS

2 Sleutels
2 Clés de montage



code							min.	€
EE 0352H		4026851011404	2500 Watt	13,080 kg	-	1	1	1138,00
EE 03641		4026851012913	3000 Watt	15,560 kg	-	1	1	1613,00
EE 0B33R		4026851017680	2500 Watt	17,340 kg	-	1	1	1030,00

EE 0B33R DB 201

	2500W 230V
	675 min ⁻¹
	Ø 80 - 202 mm
	1/2 " + 5/4" UNC
	790 mm
	15,5 kg



**BOORDIAMETER TOT
DIAMÈTRE DE FORAGE JUSQU'À
202 mm!**

EE 0B33R
Boorkroon
niet inbegrepen
Couronne
non-incluse





PowerLine

EE 0373G PLD 450.2 B

	3300W 230V
	1: 230 min⁻¹ 2: 525 min⁻¹ 3: 1025 min⁻¹
	1: 150 min⁻¹ 2: 340 min⁻¹ 3: 700 min⁻¹
	71 - 452 mm
	5/4" UNC
	5 m H07BQ-F
	15,3 kg

Kabel/Cable
PUR



"SNELLE SERIEMATIGE BORINGEN"
"MACHINE POUR FORAGES RAPIDES EN SÉRIE"

INCLUSIEF TOEBEHOREN
ACCESSOIRES INCLUS

2 Sleutels
2 Clés de montage



code							min.	€
EE 0373G		4026851018502	3300 Watt	18,720 kg	-	1	1	2023,00
EE 0962M		4026851011848	Voor / Pour PLD 450.2 B	30,500 kg	-	1	1	1350,00

EE 0962M PLB 450

	452 mm
	960 mm (STAAL/ACIER)
	5/4" UNC
	45°
	295 x 195 mm
	27,0 kg

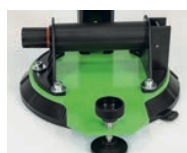

Vacuumpomp
Pompe à vide**EE 09659**
BST 125 V**EE 0964P**
BST 160/60**EE 0963W**
BST 162H**EE 0964X**
BST 182 V/S 60/P**SPECIAL
IMPACT
MACHINE**voor / pour
ESD 162

	EE 09659 BST 125 V	EE 0964P BST 160/60	EE 0963W BST 162H	EE 0964X BST 182 V/S 60/P
90° MAX Ø	125 mm	160 mm	202 mm	202 mm
500 mm (ALU)	500 mm (ALU)	850 mm (ALU)	860 mm (ALU)	995 mm (ALU)
53/46 mm (incl. aanpassingsring) (bague de réglage inclus)	53/46 mm (incl. aanpassingsring) (bague de réglage inclus)	60 mm	60 mm	60 mm
MAX	-	45°	45°	45°
L x B	-	320 x 110 mm	320 x 220 mm	330 x 250 mm
COMBI	V	-	-	V
KG	5,9 kg	10,0 kg	10,5 kg	14,0 kg

code							min.	€
EE 09659		4026851019172	BST 125 V	7,000 kg	-	1	1	410,00
EE 0964P		4026851015167	BST 160/60	12,300 kg	10	1	1	496,00
EE 0963W		4026851018793	BST 162H	12,300 kg	15	1	1	897,00
EE 0964X		4026851015730	BST 182 V/S 60/P	17,500 kg	6	1	1	924,00



EE 09646
BST 182 V/S

EE 09631
BST 250

EE 09647
BST 352 V

EE 09655
EBW 1300

90° MAX Ø	202 mm	252 mm	352 mm	-
	995 mm (ALU)	995 mm (ALU)	995 mm (ALU)	250 - 1300 mm
				60 mm
	45°	45°	45°	-
	330 x 250 mm	430 x 330 mm	400 x 310 mm	-
	V	-	V	-
	14,0 kg	15,5 kg	22,5 kg	24,5 kg

code							min.	€
EE 09646		4026851012968	BST 182 V/S	17,000 kg	6	1	1	946,00
EE 09631		4026851004826	BST 250	21,500 kg	-	1	1	898,00
EE 09647		4026851012975	BST 352 V	26,500 kg	6	1	1	1156,00
EE 09655		4026851018922	EBW 1300	27,360 kg	-	1	1	1226,00
Spanhalsadapter voor BST 182 V/S • Adaptateur de serrage pour BST 182 V/S								
EE 35829	vrac	4026851014986	Ø 60 mm	1,500 kg	-	1	1	161,00
Aanpassingsring voor BST • Bague de réglage pour BST								
EE 35820	vrac	4026851007230	60 x 53 mm	0,048 kg	-	1	1	15,50
EE 35821	vrac	4026851007247	60 x 43 mm	0,104 kg	-	1	1	15,30
Vacuümset • Set Vacuüm								
EE 3585F	zak/sac	4026851013323	Voor / Pour BST 182V/S	0,433 kg	-	1	1	185,00
EE 3585G	zak/sac	4026851013330	Voor / Pour BST 352 V	0,380 kg	-	1	1	198,00



EE 096U1
USD 182TELESCOPISCH BOORSTATIEF
BÂTI DE FORAGE TÉLESCOPIQUE

	182 mm
	1160 - 3018 mm
	60 mm
	180°
	302 x 219 mm
	39,9 kg

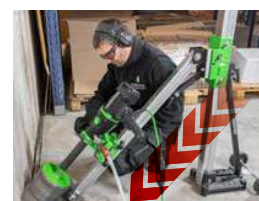

code							min.	€
EE 096U1		4026851019639	USD 182	43,400 kg	-	1	1	2688,00*

*Prijs voor tel. boorstatief excl. boormotor & boorkroon
*Prix pour bâti de forage télescopique hors carotreuse et couronne

Toebehoren voor diamantboormachines
Accessoires pour machines de forage diamanté

EE 35876

2.

VP04
Max Ø 350 mm
80 l / min

4.



5.

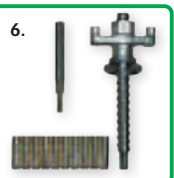

code							min.	€
1. Universele Water-/stofopvangring • Anneau collecteur d'eau/poussière universel								
EE 35876	vrac	4026851018939	UAR 162G	max. Ø 162 mm	0,400 kg	-	1	75,60
EE 3586P	vrac	4026851019462	UAR 252G	max. Ø 252 mm	0,860 kg	-	1	88,20
2. Telescopisch snelspanzuil • Support télescopique, blocage rapide								
EE 35730	vrac	4026851003980		1,7 m - 3,0 m	8,950 kg	-	1	446,00
3. Vacuümpomp • Pompe à vide • VP (Darm niet inbegrepen / Tuyau non inclus)								
EE 09204	vrac	4026851007254	VP 04	DBE 250 - 352	12,050 kg	-	1	1438,00
4. Vacuümslang incl. 2 koppelingen • Flexible de la pompe à vide, 2 raccord incl.								
EE 35855	vrac	4026851003898		L = 3 m	1,014 kg	-	1	38,50
5. Vacuümplaat • système de fixation sous vide								
EE 35851	vrac	4026851003881		BST 103 - 152	3,559 kg	-	1	227,00
6. Bevestigingsset beton • Set de fixation pour le béton								
EE 35720	vrac	4026851004864		M12 - Ø 15 mm + 10 inslagankers / chevilles à frappe	1,258 kg	-	1	45,50
7. Bevestigingsset voor metselwerk • Set de fixation pour maçonnerie								
EE 35724	vrac	4026851005175		M12 - Ø 20 mm	0,714 kg	-	1	32,00
8. Waterdrukvat • Réservoir d'eau sous pression								
EE 35812	vrac	4026851010292		10 l - 6 bar	6,500 kg	-	1	263,00
9. Centreerboor voor boorkroon • Mèche de centrage pour couronne								
EE 36391	vrac	4026851005472		max = 450 mm Voor / Pour 5/4"	1,096 kg	-	1	79,00
10. Spanhalsadapter voor BST 182 V/S • Adaptateur de serrage pour BST 182 V/S								
EE 35829	vrac	4026851014986		Ø 60 mm	1,500 kg	-	1	161,00
11. Debiet indicator voor kroonboormachines waterstroomb • Indicateur de débit pour carottes - débit d'eau								
EE 35819	vrac	4026851018229		Ø 60 mm	0,182 kg	-	1	83,10



9.



11.



EE 0650L
EPG 400 WP

	500W 230V
	370 mm
	0 - 60 min⁻¹
	5 m H07RN-F
	3,8 kg



Multifunctioneel :
Schuren - gladmaken - krabben - schaven
Multifonctionnelle :
Poncer - lisser - gratter - raboter

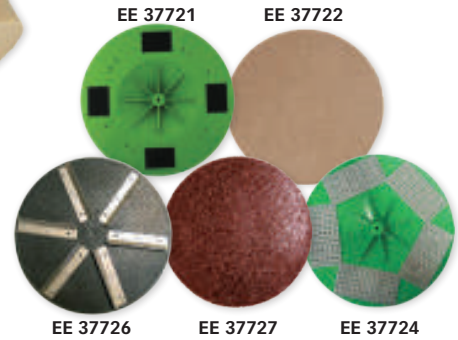

INCLUSIEF TOEBEHOREN
ACCESSOIRES INCLUS

1 x EE 37721
1 x EE 37722



code							min.	€
EE 0650L	koffer/coffre	4026851012333	500 Watt	10,480 kg	-	1	1	573,00
Basis steunschijf • Support de base								
EE 37721	vrac	4026851010957	Ø 370 mm	0,733 kg	-	1	1	27,50
Synthetische spons • Éponge synthétique								
EE 37722	vrac	4026851010964	Ø 400 mm	0,377 kg	-	1	1	21,30
Schaafbord • Plateau à raboter								
EE 37726	vrac	4026851011558	Ø 380 mm	1,160 kg	-	1	1	72,80
Schuurschijf • Disque abrasif								
EE 37727	vrac	4026851011565	Ø 370 mm	0,388 kg	-	1	1	22,70
Krabbord schijf • Plateau à gratter								
EE 37724	vrac	4026851011480	Ø 370 mm	1,150 kg	-	1	1	78,80

EE 065A3
EPG 300 A

	300 mm
	0 - 180 min⁻¹
	18 V 5,2 Ah Li-Ion
	4,270 kg



CAS CORDLESS ALLIANCE SYSTEM

ACCU

+ EXTRA



INCLUSIEF TOEBEHOREN
ACCESSOIRES INCLUS

1 x EE 3772C / 1 x EE 3772D
2 x EE 37731 (batterij / batterie)
1 x EE 37734 (Lader / chargeur)

Vrijheid van beweging | 30 minuten autonomie.
Idéaal voor snel werken op grote oppervlakken.
Liberté de mouvement | 30 min d'autonomie.
Parfait pour travailler rapidement sur de larges surfaces.

code							min.	€
EE 065A3	koffer/coffre	4026851019394	18 V, 5,2 Ah Li-Ion	5,900 kg	-	1	1	1008,00
Basis steunschijf • Support de base								
EE 3772C	vrac	4026851019646	Ø 300 mm	0,520 kg	-	1	1	24,75
Synthetische spons • Éponge synthétique								
EE 3772D	vrac	4026851019653	Ø 320 mm	0,340 kg	-	1	1	20,25
Rubberen spons • Caoutchouc spongieux								
EE 3772E	vrac	4026851019660	Ø 300 mm	0,500 kg	-	1	1	60,20
Schuurbord • Taloché								
EE 37728	vrac	4026851011701	Ø 380 mm	0,680 kg	-	1	1	21,80



NEWEE 05710
WPN 180EE 05723
EPO 200-3R

	1200W 230V	1500W 230V
	Max. 180 mm 100 - 180 mm	3 x 100 mm
	1.500 min ⁻¹ 2.800 min ⁻¹	2.000 min ⁻¹ 3.000 min ⁻¹
	M14	3 x M14m velcro
	5 m H07RN-F	5 m H07RN-F
	4,4 kg	5,2 kg
	/	compatibel



EE 05710









Steunschijf niet inbegrepen
Support non-include**NEW**

EE 05723

Polijs pads niet inbegrepen
Patins de polissage non-inclus

- Schuren, opruimen en polijsten van diverse minerale oppervlakken, zoals natuursteen, kunststeen, beton en meer.
Pouçage, rafraîchissement et polissage de diverses surfaces minérales, telles que la pierre naturelle, la pierre artificielle, le béton et plus encore.

- Perfecte aanvulling op grote polijstmachines – vooral voor randbewerking.
Complément parfait aux grandes machines de polissage – en particulier pour le traitement des bords.

code							min.	€
EE 05710		4026851003515	1200 Watt	4,740 kg	-	1	1	472,00
EE 05723		4026851018663	1500 Watt	5,200 kg	-	1	1	705,00



Rubber steunschijf "Flexibel" voor nat & droog gebruik
Support "Flexible" pour patins de polissage pour utilisation à eau et à sec

code								min.	€
DX 745100		5420000034617	M14	100 mm	0,101 kg	-	1	1	17,97
DX 745125		5420000068605	M14	125 mm	0,170 kg	-	1	1	20,40

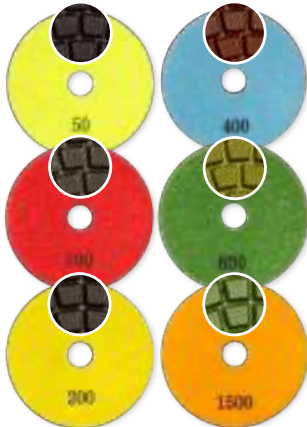

Diamantpads - nat polijsten
Patins de polissage - polissage à eau



code								min.	€	
Prijs per stuk • Prix par pièce										
DX 752105		5420000071650		50	100 mm	0,140 kg	-	1	1	15,00
DX 752110		5420000071667		100	100 mm	0,140 kg	-	1	1	15,00
DX 752120		5420000071674		200	100 mm	0,140 kg	-	1	1	15,00
DX 752140		5420000071681		400	100 mm	0,140 kg	-	1	1	15,00
DX 752180		5420000071698		800	100 mm	0,140 kg	-	1	1	15,00
DX 752195		5420000071704		1500	100 mm	0,140 kg	-	1	1	15,00



VLEKVIJ
SANS TACHES



DX 750904

DX 750814



DX 751908

Set diamant polijstpads
Patins de polissage en set

code								min.	€
SET : 3-STEPS + steunschijf • SET : 3-STEPS + disque de support									
DX 750814		5420000071445	H1 → H3	100 mm	0,246 kg	-	1	1	87,00
DX 750904		5420000071438	H1 → H3	125 mm	0,390 kg	-	1	1	89,00
SET : 7-STEPS + steunschijf • SET : 7-STEPS + disque de support									
DX 751908		5420000068612	50 → 3000	125 mm	0,430 kg	-	1	1	122,00

EE 0620N
ELS 225.1

EE 0620U
ELS 225 BL

	590W 230V	1050W 230V
	225 mm incl.	225 mm incl.
	1.050 - 1.600 min ⁻¹	950 - 1.950 min ⁻¹
	M14	M14
	5 m H07RN-F	5 m H07RN-F
	compatibel	compatibel
	4,9 kg	3,45 kg

INCLUSIEF TOEBEHOREN
ACCESSOIRES INCLUS
**Draagzak + verlengstuk + schuimring + borstelring +
schuurschijf (1 x K80 - K100 - K120)**
**Sac de transport + rallonge + anneau en mousse +
brosse + disque de ponçage (1 x K80 - K100 - K120)**
Verbeterde aandrijving = minder trillingen
Amélioration de la transmission = moins de vibrations
Verbeterde afschermingskop met 2 uitvoeringen : rubber en borstel
Protection améliorée de la coiffe avec 2 applications : caoutchouc et brosse
Met afzuiging
Avec aspiration
VACU-GLIDE

EE 0620N

EE 0620U

NEW
Borstelloze motor
zonder flexibele as
Moteur sans balais et
sans arbre flexible

EE 37659



EE 37631



EE 37632



EE 3722C



ZW EE7620L598



code						min.	€
EE 0620N		4026851015303	590 Watt	9,840 kg	12	1	785,00
EE 0620U		4026851020659	1050 Watt	9,000 kg	12	1	805,00
Extra handgreep voor ELS 225.1 • Poignée auxiliaire pour ELS 225.1							
EE 37659		4026851015242	PVC	0,600 kg	-	1	52,50
Basisplaat voor ELS 225.1 - ELS 225 BL & ETS 225 • Plaque pour ELS 225.1 - ELS 225 BL & ETS 225							
EE 37631		4026851008947	Ø 225 mm	0,080 kg	-	1	19,70
Schuimrubberen steunzool met 6 perforaties • Support en mousse avec 6 perforations							
EE 37632		4026851008954	Ø 225 mm	0,044 kg	-	1	20,30
Schuimring VacuGlide • Anneau en mousse Vacu-Glide							
EE 3722C		4026851015310	-	0,200 kg	-	1	21,30
Aandrijfflexibel voor ELS 225.1 / wisselstuk • Flexible d'entraînement pour ELS 225.1 / pièce de rechange							
ZW EE7620L598		-	-	0,422 kg	-	1	98,70

SCHUURPAPIER "MULTI-HOLE" ZIE BLZ. 106 • PAPIER À PONCER "MULTI-HOLE" VOIR P. 106

SCHUURMACHINE VOOR DROOGBOUW
PONCEUSE POUR PLAQUISTE

EE 06203
 ETS 225

	700W 230V
	225 mm Ø MM
	0 - 1.450 min⁻¹ R P M
	5 m H07RN-F
	compatibel
	2,9 kg KG

INCLUSIEF TOEBEHOREN • ACCESSOIRES INCLUS

 velcro schuurpapier P60 - P80 - P100 - P220 + sleutel
 Papier à poncer velcro P60 - P80 - P100 - P220 + clé

code							min.	€
EE 06203	koffer/coffre	4026851005977	700 Watt	5,840 kg	-	1	1	356,00
Basisplaat voor ELS 225.1 & ETS 225 • Plaque pour ELS 225.1 & ETS 225								
EE 37631	vrac	4026851008947	Ø 225 mm	0,080 kg	-	1	1	19,70
Schuimrubberen steunzool met 6 perforaties • Support en mousse avec 6 perforations								
EE 37632	vrac	4026851008954	Ø 225 mm	0,044 kg	-	1	1	20,30

SCHUURMACHINE VOOR ISOLATIEPLATEN
PONCEUSE POUR PANNEAUX ISOLANTS

EE 0620F
 EWS 400

	800W 230V
	370 mm Ø MM
	0 - 85 min⁻¹ R P M
	5 m H07RN-F
	compatibel
	3,9 kg KG

INCLUSIEF TOEBEHOREN
ACCESSOIRES INCLUS

 1x velcro schuurpapier P24
 1x papier à poncer velcro P24

EE 37671

code							min.	€
EE 0620F		4026851012562	800 Watt	6,160 kg	-	1	1	495,00
Velcro schuurpapier voor EWS 400 • Papier à poncer velcro pour EWS 400								
EE 37671		4026851012838	Ø 370 mm - P24	0,150 kg	-	1	1	78,00



EE 0630F



EE 06324
EE 06325



EE 0633J



EE 0633H

EE 0633L

PKD/PCD

EE 0630F
EBS 120.1

EE 06324
EBS 125.4 O

EE 06325
EBS 125.4 RO

EE 0633J
EBS 1802

EE 0633L
EBS 1802 SH

EE 0633H
EBS 180 H



	EE 0630F	EE 06324	EE 06325	EE 0633J	EE 0633L	EE 0633H
	1400W 230V	1500W 230V	1500W 230V	1800W 230V	1800W 230V	2500W 230V
	125 mm incl.	125 mm incl.	125 mm incl.	125 mm incl.	125 mm incl. (PKD/PCD)	180 mm incl.
	8.000 min ⁻¹	10.000 min ⁻¹	6.000 min ⁻¹ 10.000 min ⁻¹	10.000 min ⁻¹	10.000 min ⁻¹	8.500 min ⁻¹
	22,2 mm	22,2 mm	22,2 mm	22,2 mm	22,2 mm	22,2 mm
	5 m H07RN-F	5 m H07RN-F	5 m H07RN-F	5 m H07RN-F	5 m H07RN-F	5 m H07RN-F
	compatibel	compatibel	compatibel	compatibel	compatibel	compatibel
	3,5 kg	4,7 kg	4,7 kg	5,9 kg	5,9 kg	8,4 kg

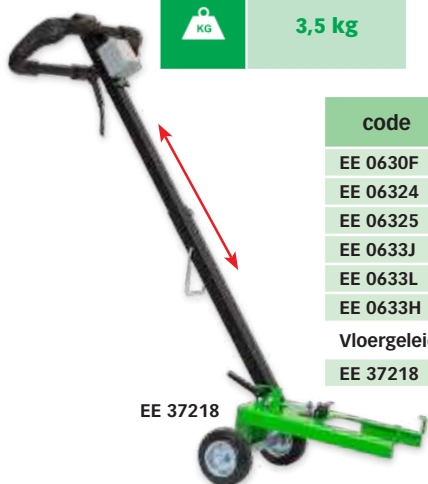

EE 37218

code							min.	€
EE 0630F	koffer/coffre	4026851016058	1400 Watt	7,100 kg	-	1	1	528,00
EE 06324	koffer/coffre	4026851003676	1500 Watt	10,020 kg	-	1	1	538,00
EE 06325	koffer/coffre	4026851003683	1500 Watt	10,060 kg	-	1	1	595,00
EE 0633J	koffer/coffre	4026851010056	1800 Watt	11,360 kg	-	1	1	643,00
EE 0633L	koffer/coffre	4026851010087	1800 Watt	11,540 kg	-	1	1	925,00
EE 0633H	koffer/coffre	4026851012982	2500 Watt	15,020 kg	-	1	1	1091,00
Vloergeleidingsframe • Cadre de guidage au sol								
EE 37218	koffer/coffre	4026851018915	EBS 125 - EBS 1802 - 180H	8,500 kg	-	1	1	509,00

Voorkomt dichtslijpen van de segmenten.
Pas d'engluement des segments.

code							min.	€
PKD Diamant komschijf - Ø 125 mm • Meule diamantée PCD - Ø 125 mm								
EE 37115		4026851010193	Voor / Pour EBS 1802 SH	0,466 kg	-	1	1	248,00

**ANDERE SCHIJVEN OP BLZ. 62 - 63
AUTRES DISQUES SUR P. 62 - 63**

PKD : Poly Cristal Diamant



EE 37115



EE 06346
EBS 235.1

	2200W 230V
	235 mm incl.
	1.380 min⁻¹
	M20 Special
	5 m H07RN-F
	compatibel
	38 kg



Exclusief slijpschijf
Disque à poncer non-inclus



Speciaal voor vloerooppervlakken met vloergeleidingssysteem.
Special pour les surfaces de sols avec système de guidage.



code							min.	€
EE 06346		4026851011800	2200 Watt	45,000 kg	-	1	1	1670,00
Diamant slijpschijf voor beton - EBS 235.1 • Meule diamantée pour béton - EBS 235.1								
EE 37117		4026851011633	Ø 235 mm	1,520 kg	-	1	1	308,00
Diamant slijpschijf voor chape - EBS 235.1 • Meule diamantée pour chape - EBS 235.1								
EE 37135		4026851019110	Ø 235 mm	3,020 kg	-	1	1	350,00
Diamant slijpschijf PCD - EBS 235.1 • Meule diamantée PCD - EBS 235.1								
EE 37136		4026851019127	Ø 235 mm	2,780 kg	-	1	1	587,00





EE 06231

ELS 125 D

	1200W 230V
	125 mm incl.
	8.000 min ⁻¹
	22,2 mm
	5 m H07RN-F
	compatibel
	5,3 kg

TOEBEHOREN INBEGREPEN
ACCESSOIRES INCLUS

Draagzak + Diamant schuurschijf universeel
+ Montagesleutel
Sac de transport + Meule diamantée universel
+ Clé de montage

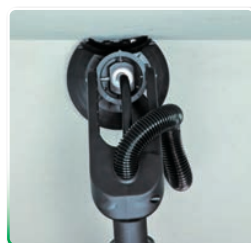

ELS 125 D is bestemd voor het droog slijpen en glad maken van bekistingsnaden, bramen en onregelmatigheden op beton. Het elektrische gereedschap mag uitsluitend in combinatie met een diamantkomschijf en een zuiger van de stofklasse M (Ref. EE 09919) gebruikt worden. Gebruik alleen slijpwielen die door de fabrikant worden aanbevolen. Deze zijn licht van gewicht en hebben een hoge concentriciteit. Het gebruik van andere slijpwielen kan een overbelasting van de machine, schade aan de lagers en gevaar voor de gebruiker veroorzaken.

ELS 125 D est destiné au meulage à sec et au lissage des coutures de coffrage, des bavures et des irrégularités sur le béton. L'outil électroportatif doit être utilisé exclusivement avec une meule assiette diamantée et un aspirateur de classe M (Réf. EE 09919). N'utilisez que les disques recommandés par le fabricant ! Des disques trop lourds ou non équilibrés peuvent conduire à la surcharge et à la détérioration de la machine.

code							min.	€
EE 06231		4026851016423	1200 Watt	10,660 kg	-	1	1	1034,00
Extra handgreep • Poignée auxiliaire								
EE 37659		4026851015242	PVC	0,600 kg	-	1	1	52,50
Diamant schuurschijf vlakschuren van beton • Meule diamantée pour meulage de surface du béton								
EE 37126		4026851016492	Ø 125 mm	0,560 kg	-	1	1	102,00
Diamant schuurschijf voor beton-lijm-plaaster • Meule diamantée pour béton-adhésif-plâtre								
EE 37128		4026851016515	Ø 125 mm	0,460 kg	-	1	1	171,00
Aandrijfflexibel voor ELS 125 / wisselstuk • Flexible d'entraînement pour ELS 125 / pièce de rechange								
ZW EE76231598	vrac	-	-	0,422 kg	-	1	1	85,50





EE 0651L
EPF 1503

	1500W 230V
	140 mm incl.
	4000 min⁻¹
	M14
	5 m H07RN-F
	compatibel
	3,9 kg



INCLUSIEF TOEBEHOREN
ACCESSOIRES INCLUS

1 x Kruis / 16 sterren
1 x Tourniquet / 16 étoiles



code							min.	€
EE 0651L	koffer/coffre	4026851009531	1500 Watt	10,200 kg	-	1	1	663,00

Kruis compleet met 16 gekartelde freeswielen (hardmetaal)
Tourniquet avec 16 étoiles de fraisage coudées (carbure)

EE 37428	vrac	4026851009586	Voor / Pour EPF 1503	1,050 kg	-	1	1	191,00
-----------------	------	---------------	----------------------	----------	---	---	---	---------------

EE 0651M
EPF 200-3

	1500W 230V
	3 x 100 mm.
	3000 min⁻¹
	3 x Ø 22,2 mm
	5 m H07RN-F
	compatibel
	5,4 kg



Freesdieptebegrenzing
Limitation de la profondeur
de fraisage
max. 5 mm



Schijven niet inbegrepen
Disques non-inclus



INCLUSIEF TOEBEHOREN
ACCESSOIRES INCLUS

Montagesleutel
Clé de montage



code							min.	€
EE 0651M	koffer/coffre	4026851018151	1500 Watt	5,400 kg	-	1	1	645,00

Carbide-freeschijf grof 100 mm • Disque de fraisage en carbure grossier 100 mm

EE 37131	vrac	4026851018175	Voor / Pour EPF 200-3	0,180 kg	-	1	1	38,25
-----------------	------	---------------	-----------------------	----------	---	---	---	--------------

Diamant schuurschijf PKD 100 mm - minerale ondergronden
Disque abrasif PCD 100 mm - surfaces minérales

EE 37125	vrac	4026851015495	Voor / Pour EOF 100.1/EPF 200-3	0,350 kg	-	1	1	141,00
-----------------	------	---------------	------------------------------------	----------	---	---	---	---------------



EE 06535
EOF 100.1

	1400W 230V
	100 mm
	10.000 min ⁻¹
	22,2 mm
	3 m H05RN-F
	compatibel
	3,4 kg



EE 06535

Diepteregeling
Réglage de profondeur
0,1 mm → 1,0 mm



Betere afzuiging
Aspiration améliorée

INCLUSIEF TOEBEHOREN
ACCESSOIRES INCLUS

Montagesleutel
Clé de montage

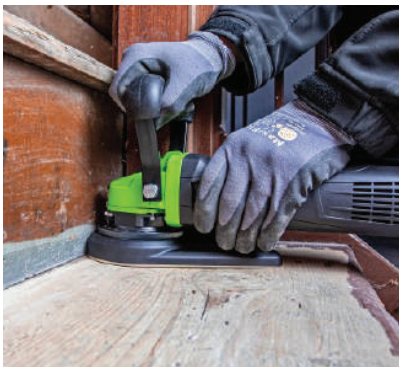

code							min.	€
EE 06535	koffer/coffre	4026851017611	1400 Watt	7,060 kg	-	1	1	297,00
Hardmetalen schuurschijf 100 mm - ondergronden in hout Disque abrasif carbide 100 mm - surfaces en bois								
EE 37124	vrac	4026851015327	Voor / Pour EOF 100.1	0,350 kg	-	1	1	125,00
Diamant schuurschijf PKD 100 mm - minerale ondergronden Disque abrasif PCD 100 mm - surfaces minérales								
EE 37125	vrac	4026851015495	Voor / Pour EOF 100.1/EPF 200-3	0,350 kg	-	1	1	141,00



EE 37124



EE 37125



EE 06652
ERC 350



	1250W 230V
	125 x 22,2 mm Ø MM
	12.000 min⁻¹
	80 - 350 mm Ø MM
	5 m H07RN-F
	compatibel
	14,9 kg

INCLUSIEF TOEBEHOREN
ACCESSOIRES INCLUS
Montagesleutel
Clé de montage



Snijschijf niet inbegrepen
Disque à tronçonner non-incluse



EE 37467
Adapter/Adaptateur
ERC 350

	40 - 80 mm Ø MM
--	---------------------------

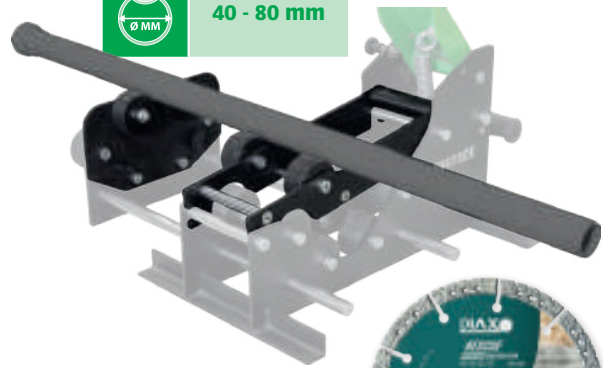

DX 375125

code							min.	€
EE 06652	koffer/coffre	4026851018762	1250 Watt	23,800 kg	-	1	1	968,00
Adapter voor buizen van Ø 40 mm tot Ø 80 mm • Adaptateur pour tubes de Ø 40 mm jusqu'au Ø 80 mm								
EE 37467		4026851020680	Voor / Pour ERC 350	3,700 kg	-	1	1	162,00
Diamantdoorslijpschijf Ø 125mm "RESCUE" Disque diamant Ø 125 mm "RESCUE"								
DX 375125		5420000043299	Ø 125/22,2 mm	0,400 kg	-	1	1	49,10
Diamantsnijden en afschuinschijf Ø 125 mm "MULTI-TASK" Disque à tronçonner et chanfreiner diamanté Ø 125 mm "MULTI-TASK"								
DX 216126		5420000075610	Ø 125/22,23 mm	0,324 kg	-	1	1	82,00



DX 216126

11 mm

DUST
PROTECTION
SYSTEM

Mineral dust may cause cancer!

EE 0660P
EDS 181

	2300W 230V
	7500 min ⁻¹
	4300 min ⁻¹
	58 mm (Ø 180 mm) 63 mm (Ø 200 mm)
	incl. 180 x 22,2 mm (max. 200 mm)
	5 m H07RN-F
	compatibel
	7,7 kg



EE 0660P



INCLUSIEF TOEBEHOREN • ACCESSOIRES INCLUS

1 x Diamantschijf beton/natuursteen (Ø180 mm)
Aansluiting voor stofzuiger / water
1 x Disque diamanté béton/pierre naturelle (Ø180 mm)
Raccord pour aspirateur / eau

- Ideaal voor vensterbanken, platen, terazzo, gevelstenen, saneren van vloervoegen.
Idéal pour tablettes de fenêtres, rénovation des joints de sols, dalles de façade, dalles en terazzo, plans de travail.
- Traploze verstelling van de zaagdiepte zonder gereedschap.
Réglage en continu de la profondeur de coupe sans outil.
- Asvergrendeling voor makkelijk en snel verwisselen van het zaagblad.
Blocage de l'arbre pour un changement facile et rapide du disque.
- Kantgeleider. / Guide latéral.

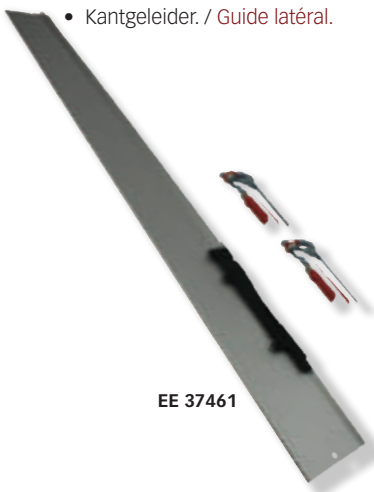

EE 37461

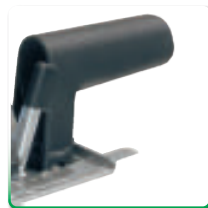

code						min.	€
EE 0660P	koffer/coffre 4026851013552	2300 Watt	17,820 kg	-	1	1	1006,00

TOEBEHOREN VOOR EDS 181 OP BLZ. 35 • ACCESSOIRES POUR EDS 181 P. 35



EE 0660V
EDS 125

	1250W 230V
	Max. 125 x 22,2 mm
	12.000 min⁻¹
	36 mm
	5 m H05VV-F
	compatibel met toebehoren avec accessoires
	2,9 kg



INCLUSIEF TOEBEHOREN • ACCESSOIRES INCLUS

- 1 x Diamantschijf beton/natuursteen (Ø125 mm)
- Aansluiting voor stofzuiger / water + koffer
- 1 x Disque diamanté béton/pierre naturelle (Ø125 mm)
- Raccord pour aspirateur / eau + coffre

- Ideaal voor vensterbanken, platen, terazzo, gevelstenen, saneren van vloervoegen.
Idéal pour tablettes de fenêtres, rénovation des joints de sols, dalles de façade, dalles en terazzo, plans de travail.
- Traploze verstelling van de zaagdiepte zonder gereedschap.
Réglage en continu de la profondeur de coupe sans outil.
- Rolgeleidingswagen ter bescherming van het werkkoppervlak.
Chariot avec rouleau de guidage pour la protection du matériau à couper.

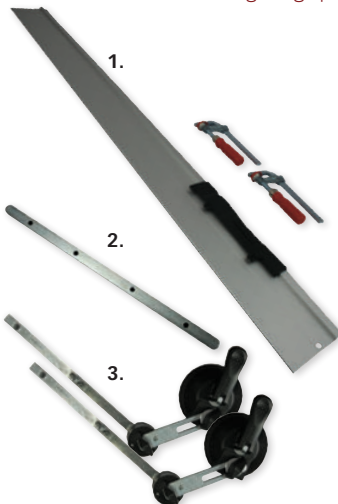
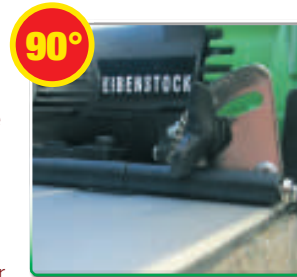

code							min.	€
EE 0660V	koffer/coffre	4026851013835	1250 Watt	7,340 kg	20	1	1	286,00
Geleidingsrail voor EDS 125 - EDS 181 • Rail de guidage pour EDS 125 - EDS 181								
1. EE 37461		4026851012272	750 mm	1,200 kg	-	1	1	106,00
EE 37462		4026851012289	1500 mm	2,390 kg	-	1	1	142,00
Verbinding voor geleidingsrail / EDS 125 - EDS 181 • Raccord pour rail de guidage / EDS 125 - EDS 181								
2. EE 37463		4026851012821	-	0,120 kg	-	1	1	37,90
Zuignap voor geleidingsrail / EDS 125 - EDS 181 • Ventouse pour rail de guidage / EDS 125 - EDS 181								
3. EE 37464		4026851013361	per 2 st - par 2 pcs	1,050 kg	-	1	1	199,00

TOEBEHOREN VOOR EDS 125 & EDS 181 • ACCESSOIRES POUR EDS 125 & EDS 181

Snijtafel voor EDS 125 • Table de coupe pour EDS 125

code						min.	€
EE 37466		4026851014382	ETT 1200 - 1200 mm	18,000 kg	-	1	522,00
Verlengstuk voor snijtafel ETT • Rallonge pour table de coupe ETT							
EE 09803		4026851014412	167 x 485 mm	2,132 kg	-	1	104,00

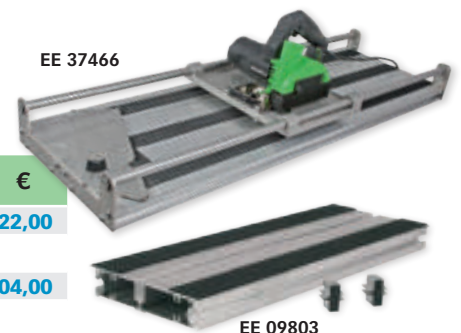

EIBENSTOCK

DIAMANTAFKORTZAAG - MACHINES
SCIE CIRCULAIRE POUR PIERRE - MACHINES



EIBENSTOCK
Power Tools



PROMO PACK

SOFT START

EE AP300
EST 350.3

	2400W 230V
	3900 min⁻¹
	250 mm
	120 mm
	2 x incl. 350 x 25,4 mm
	2,2 m H07RN-F
	compatibel
	19,6 kg

**2X
POWER N
GRATIS
GRATUIT**

Blokkerings-
systeem.
Système de
blocage.

Versterkte basis
Base renforcée



INCLUSIEF TOEBEHOREN
ACCESSOIRES INCLUS

- 2 x Diamantschijf Prodiaxo
Power N Ø 350 mm
+ montagesleutels
- 2 x Disque diamanté Prodiaxo
Power N Ø 350 mm
+ Clés de montage

code					min.	€
EE AP300	5420000070349	2400 Watt	24,500 kg	12	1	1 679,00

Met aanloopstroombegrenzing • Avec limiteur de courant

Blokkerings-
systeem.
Système de
blocage.

**Incl. 1 schijf gratis
1 disque gratuit incl.**



EE 0663B
HST 350.3

	2300W 230V
	3900 min⁻¹
	230 mm
	120 mm
	1 x incl. 350 x 25,4 mm
	2,2 m H07RN-F
	compatibel
	19,0 kg

	80 mm	100 mm	120 mm
	230 mm	210 mm	150 mm

TOEBEHOREN • ACCESSOIRES

- Montagesleutels /
1 x Diamantschijf (Laser Turbo) Ø350 mm
Clés de montage /
1 x Disque diamanté (Laser Turbo) Ø350 mm

code					min.	€
EE 0663B	4026851020512	2300 Watt	21,000 kg	12	1	1 425,00



EE 0682A

ETR 400.1 P

	2850W 230V
	1 x incl. 400 x 25,4 mm
	1950 min ⁻¹
	152 mm
	5 m H07RN-F
	compatibel
	13,4 kg

EE 0682E

ETR 400.2 P

	2850W 230V
	1 x incl. 400 x 25,4 mm
	1950 min ⁻¹
	152 mm
	5 m H07RN-F
	-
	11,4 kg



INCLUSIEF TOEBEHOREN • ACCESSOIRES INCLUS

Aansluiting voor stofzuiger - water / Montagesleutels
Diamantschijf voor beton
Raccord pour aspirateur - eau / Clés de montage
Disque diamanté pour béton



EE 0682A

Speciaal voor gebruik met rail
Spécial pour utilisation avec rail

- Geen kick-back en trekt in het materiaal
Pas de rebond et pénètre dans la matière

INCLUSIEF TOEBEHOREN • ACCESSOIRES INCLUS

Aansluiting voor water / Montagesleutels
1 x Diamantschijf voor beton
Raccord pour eau / Clés de montage
1 x Disque diamanté pour béton

SOFT START



EE 0682E



- Geen kick-back en trekt in het materiaal
Pas de rebond et pénètre dans la matière



EE 3744N

SET : 2 x geleidingsrail 100 cm + machinehouder
+ 1 x verbindingsstuk + montagestuk
SET : 2 x rail de guidage 100 cm + support de
machine + 1 x connecteur + montage.

EE 3744P

1 x geleidingsrail 100 cm
+ verbindingsstuk + montagestuk
1 x rail de guidage 100 cm
+ connecteur + montage.

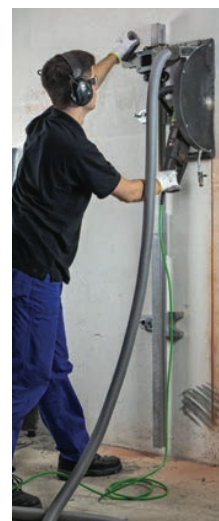

code							min.	€
EE 0682A		4026851018076	2850 Watt	15,400 kg	-	1	1	1647,00
EE 0682E		4026851019547	2850 Watt	13,400 kg	-	1	1	1385,00
Geleidingsrail-set voor ETR 400.1 P • Set rail de guidage pour ETR 400.1 P								
EE 3744N		4026851015693	200 cm	18,500 kg	-	1	1	1125,00
Verlengstuk voor geleidingsrail • Rallonge pour rail de guidage								
EE 3744P		4026851015709	100 cm	6,000 kg	-	1	1	370,00

EIBENSTOCK

HAAKSE SLIJPER - MACHINES
MEULEUSE D'ANGLE - MACHINES



EIBENSTOCK
Power Tools



**PROMO
PACK**

EE 0681DX
ETR 230.1

	2600W 230V
	6500 min ⁻¹
	2 x incl. 230 x 22,2 mm
	65 mm
	5 m H07RN-F
	compatibel
	7,6 kg

SOFT START



**2X
POWERXTM
INCL.**

INCLUSIEF TOEBEHOREN
ACCESSOIRES INCLUS

2 x Diamantschijf Prodiaxo
Power XTM Ø 230 mm
+ montagesleutels
2 x Disque diamanté Prodiaxo
Power XTM Ø 230 mm
+ Clés de montage

Met afzuigkap
Avec capot d'aspiration



code						min.	€
EE 0681DX	4026851021311	2600 Watt	10,150 kg	-	1	1	452,00



NEW

EFS 200
EE 0662R

	1400W 230V
	200 mm incl.
	8.000 min ⁻¹
	22,2 mm
	5 m H07RN-F
	compatibel
	5,6 kg



Ideaal voor
het demonteren
van ramen en deuren
Idéal pour le démontage
de fenêtres et de portes

Schijf inbegrepen
Disque inclus

INCLUSIEF TOEBEHOREN
ACCESSOIRES INCLUS

1 x Schijf Ø 200 mm inbegrepen
+ montagesleutel
1 x Disque Ø 200 mm inclus
+ clé de montage



Hoek- of rechte snede dankzij
180° rotatie van de bodemplaat -
gereedschapsloos.
Coupe d'angle ou coupe droite
grâce à la rotation à 180° de
la plaque de base, sans outil.

code						min.	€
EE 0662R	4026851020925	1400 Watt	9,300 kg	-	1	1	806,00



	EE 06703 EMF 125.2	EE 0671A EMF 150.1	EE 0672C EMF 180.2
--	------------------------------	------------------------------	------------------------------

	1700W 230V	2300W 230V	2300W 230V
	7500 min⁻¹	7500 min⁻¹	3100 min⁻¹
	-	4300 min⁻¹	2200 min⁻¹
	2 x incl. 125 x 22,2 mm	2 x incl. 150 x 22,2 mm	2 x incl. 180 x 22,2 mm
	30 mm	45 mm	60 mm
	30 mm	46 mm	60 mm
	5 m H07RN-F	5 m H07RN-F	5 m H07RN-F
	compatibel	compatibel	compatibel
	3,5 kg	6,1 kg	8,2 kg

EE 06703

EE 0671A
Met afzuigkap
Avec capot d'aspiration

EE 0672C

- Parallele stand van het handvat voor een optimale geleiding.
Position parallèle de la poignée pour un guidage parfait.
- Regelbare diepte- en breedte-instelling.
Réglage de la profondeur et de la largeur de coupe.

INCLUSIEF TOEBEHOREN • ACCESSOIRES INCLUS
EMF 125.2
2 x Diamantschijf / Disque diamanté (Ø125 mm)
EMF 150.1
2 x Diamantschijf / Disque diamanté (Ø150 mm)
EMF 180.2
2 x Diamantschijf / Disque diamanté (Ø180 mm)

code							min.	€
EE 06703	koffer/coffre	4026851017048	Ø 125 mm	7,740 kg	-	1	1	670,00
Afzuigkap met veer • Capot d'aspiration avec ressort								
EE 0671A	koffer/coffre	4026851016201	Ø 150 mm	14,120 kg	20	1	1	780,00
EE 0672C	koffer/coffre	4026851017697	Ø 180 mm	18,060 kg	-	1	1	1087,00

1800W
EXTRA POWER

VOOR / POUR
YTONG & POROTON



EE 06644
EDB 480.1

	1800W 230V
	480 mm
	3.100 / min
	5 m H07RN-F
	6,1 kg

1 mes voor alle toepassingen
1 lame pour toutes les applications



Voor het snijden van Poroton, geperforeerde baksteen, cellenbeton, hout.
Pour couper Poroton, brique perforée, béton cellulaire, bois.

Ergonomische handgreep kan gemonteerd worden op beide kanten van de machine.
Poignée ergonomique pouvant être monté sur les 2 cotés de la machine.

Robuuste bladstructuur voor een nauwkeurige snede.
Structure de la lame robuste pour une découpe précise.



Ergonomische handgreep kan gemonteerd worden op beide kanten van de machine.

Poignée ergonomique pouvant être monté sur les 2 cotés de la machine.

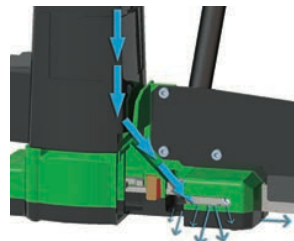

Motorbescherming tegen stof.
Voor gebruikers met speciale behoeften.
Geïntegreerde blaasfunctie.

Protection du moteur contre la poussière.
Pour les utilisateurs ayant des besoins spéciaux.
Fonction soufflerie intégrée.

code							min.	€
EE 06644		4026851015853	1800 Watt	8,920 kg	-	1	1	722,00
Vervang zaagblad voor EDB 480.1 • Lame de rechange pour EDB 480.1								
EE 37452		4026851014672	480 mm	0,200 kg	-	1	1	139,00

WATERRECYCLINGSYSTEEM
SYSTÈME DE RECYCLAGE D'EAU
EE 09305
WRS 50

	1200W 230V
	6 l/min
	50 l
	18 l
	10 m H07RN-F
	18 kg



INCLUSIEF TOEBEHOREN • ACCESSOIRES INCLUS
5 m zuigslang + 5 m waterslang met aansluiting en stroomindicator + 1 filterzak
5 m de tuyau d'aspiration + 5 m de tuyau d'eau avec raccord et indicateur de débit + 1 sac de filtrage

- Extractie van boorspoeling en water.
- Geen wateraansluiting nodig op locatie.
- Duurzaam en grondstofbesparend door hergebruik van het water.
- Professionele afvoer van bouwslib via speciale filterzakken
- Aspiration de la boue de forage et de l'eau.
- Pas de raccordement d'eau nécessaire sur le chantier.
- Durable et respectueux des ressources grâce à la réutilisation de l'eau.
- Élimination des boues de chantier dans les règles de l'art grâce à des sacs filtrants spéciaux.

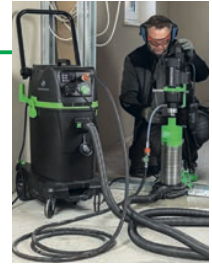

NIET geschikt voor droogzuigen!
Het gebruik van een speciale filterzak is verplicht!
PAS conçu pour l'aspiration à sec!
Il est impératif d'utiliser un sac filtrant spécial !

code						min.	€
EE 09305		4026851019745	1200 Watt	25,200 kg	1	1	1716,00
Filterzak voor WRS 50 • Sac de filtrage pour WRS 50							
EE 35352		4026851020574	-	0,540 kg	1	1	59,00
Universele Water-/stofopvangring • Anneau collecteur d'eau/poussière universel							
EE 35876	vrac	4026851018939	UAR 162G - max. Ø 162 mm	0,400 kg	1	1	75,60
EE 3586P	vrac	4026851019462	UAR 252G - max. Ø 252 mm	0,860 kg	1	1	88,20

EE 09927 WATERAFVOERPOMP / POMPE D'ÉVACUATION D'EAU
EPS 50

	Max. 1300W 230V		3,88l/s 14.000l/h
	Max. 900W 230V		46 x 45 x 63 cm
	50 l		10 m H05VV-F
	230 mbar		15,0 kg



- Grondige absorptie en gelijktijdig wegpompen van water tot op 9 m hoogte.
- Sneller en efficiënter in ve gelijking met conventionele methoden.
- Op bouwterreinen, bij overstromingen, herstel van brandschade, beschadigingen aan pijpleidingen.
- Renovatie van platte daken, reiniging van vijvers of zwembaden en andere reinigingswerkzaamheden.
- Absorption complète et pompage simultané de l'eau jusqu'à une hauteur de 9 m.
- Plus rapide et plus efficace que les méthodes conventionnelles.
- Sur les chantiers de construction, pour les inondations, la réparation des dommages causés par les incendies, les dommages aux canalisations.
- Rénovation de toits plats, nettoyage d'étangs ou de piscines et autres travaux de nettoyage.

Incl. toebehoren
Accessoires incl.



code				L			min.	€
EE 09927		4026851017574	1300 Watt	50 L	27,760 kg	1	1	1189,00

EE 09921 SS 1401 L

EE 09915 DSS 25 A

	Max. 1250W 230V	Max. 1400W 230V
	21 l	20 l
	25 l	25 l
	210 mbar	270 mbar
	3000 cm ²	2 x 4300 cm ²
	50,5 x 38,5 x 37,5 cm	45,7 x 40 x 53,5 cm
	5 m H05VV-F	8 m H05VV-F
	7,7 kg	11,7 kg



EE 09921



EE 09915



code				L			min.	€
EE 09921		4026851015112	1250 Watt	21 L	9,920 kg	1	1	301,00
EE 09915		4026851013170	1400 Watt	20 L	18,400 kg	1	1	660,00

TOEBEHOREN VOOR ZUIGERS OP BLZ. 44
ACCESSOIRES POUR ASPIRATEURS P. 44

EE 09932 EE 09931 ESS 35 LP ESS 35 MP

	Max. 1200W 230V
	35 l
	250 mbar
	54 x 39 x 63,5 cm
	10 m H07RN-F
	16,0 kg



EE 09932



EE 09931



Stofretentiecapaciteit min. 99%
volgens BGIA stofklasse L

Capacité de rétention de poussière min.
de 99% selon la classe de poussière BGIA L



Stofretentiecapaciteit min. 99,9%
volgens BGIA stofklasse M

Capacité de rétention de poussière min.
de 99,9% selon la classe de poussière BGIA M



code				L			min.	€
EE 09932		4026851018427	1200 Watt	35 L	23,000 kg	1	1	615,00
EE 09931		4026851018410	1200 Watt	35 L	23,000 kg	1	1	725,00

NEW

EE 09919 EE 09928
DSS 35 M IP DSS 35 H IP

	Max. 1600W 230V
	25 l
	35 l
	280 mbar
	2 x 4300 cm²
	55 x 40 x 55 cm
	8 m H07RN-F
	14,0 kg



De zuigers zijn voorzien van een elektromagnetische filter einiging waarmee het opgevangen stof van een filte cassette kan worden afgeschud. De filte cassettes worden afwisselend na elkaar gereinigd, zodat een voortdurend functioneren gegarandeerd is.

L'aspirateurs sont équipé d'un dispositif électromagnétique de nettoyage du filte e permettant d'éliminer par vibration les poussières restant collées aux cassettes à filte e plissé. Les cassettes à filte e plissé sont nettoyées alternativement l'une après l'autre de manière à pouvoir garantir un travail en continu.



EE 09919



EE 09928



Stofretentiecapaciteit min. **99,9%**
volgens BGIA stofklasse **M**

Capacité de rétention de poussière min. de **99,9%** selon la classe de poussière BGIA **M**



Stofretentiecapaciteit min. **99,995%**
volgens BGIA stofklasse **H (exclusief Asbest)**

Capacité de rétention de poussière min. de **99,995%** selon la classe de poussière BGIA **H (Amiante non-inclus)**

NEW



Incl. toebehoren
Accessoires incl.

L = 5 m



Incl. toebehoren
Accessoires incl.

L = 5 m

code							min.	€
EE 09919		4026851014818	1600 Watt	25 L	20,500 kg	1	1	969,00
EE 09928		4026851024237	1600 Watt	25 L	21,000 kg	1	1	990,00



EE 35331

NEW

EE 35331
EVF 25

	25 l
	4,1 kg

Incl. toebehoren
Accessoires incl.



- Scheidingsrendement: **houtstof >99%; mineraalstof >90%**.
- Montage via een passende adapterplaat op **DSS- en ESS-stofzuigers**.
- Gemakkelijk te dragen dankzij twee zijdelings geplaatste handgrepen.
- Taux de séparation : **poussière de bois >99%; poussière minérale >90%**.
- Montage à l'aide d'une plaque d'adaptation adaptée sur les **aspirateurs DSS et ESS**.
- Transport facile grâce à deux poignées latérales.

Voorafscheider EVF 25 voor stofzuigers DSS en ESS Series
Pré-séparateur EVF 25 pour série DSS et ESS



EE 35330

EE 35328

code							min.	€
EE 35331		4026851024268	25 L	5,600 kg	1	1	289,00	
Adapterplaat • Plaque d'adaptation								
EE 35330		4026851024251	DSS-Series	1,745kg	1	1	90,00	
EE 35328		4026851019493	ESS-Series	1,780kg	1	1	77,00	

SS 1401 L

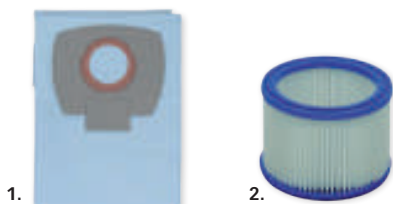
ESS 35LP - ESS 35MP
DSS 25 A/50 A - DSS 35 M iP - DSS 35 H iP

Toebehoren voor zuigers • Accessoires pour aspirateur

code							min.	€
1. Vliesfilterzak • Sac filtrant en non-tissé – voor / pour SS 1401 L								Prijs per 5 st. • Prix par 5 pcs
EE 35323		4026851014047	SS 1401 L	0,317 kg	-	1	1	35,00
2. Harmonicafilter • Filtre en harmonica – voor / pour SS 1401 L								
EE 35322		4026851014030	SS 1401 L	0,710 kg	-	1	1	43,90
3. Filterzak in plastic • Filtre en plastique – voor / pour DSS 25/50 A / DSS 35 M iP								Prijs per 5 st. • Prix par 5 pcs
EE 35320		4026851009296	DSS 25 A / DSS 35 M iP / DSS 50 A	1,000 kg	-	1	1	85,20
4. Filterzak in stof • Filtre en tissu – voor / pour DSS 25 A / DSS 35 M iP								Prijs per 5 st. • Prix par 5 pcs
EE 35321		4026851013460	DSS 25 A / DSS 35 M iP	0,560 kg	-	1	1	47,25
Filterzak in stof • Filtre en tissu – voor / pour DSS 50 A								Prijs per 4 st. • Prix par 4 pcs
EE 35363		4026851018991	DSS 50 A	0,500 kg	-	1	1	49,30
5. Vliesfilterzak 35 L • Sac filtrant en non-tissé 35 L – voor / pour ESS 35 LP/ESS 35 MP								Prijs per 5 st. • Prix par 5 pcs
EE 35362		4026851018984	ESS 35 LP/ESS 35 MP	0,680 kg	-	1	1	36,00
6. Vouwfilter • Filtre à plis – voor / pour ESS 35 LP/ESS 35 MP								
EE 35361		4026851019875	ESS 35 LP/ESS 35 MP	0,900 kg	-	1	1	50,65
7. Polyester filterset • Jeu de filtre en polyester – voor / pour DSS 25/50 A / DSS 35 M iP								Prijs per 2 st. • Prix par 2 pcs
EE 35301		4026851004307	DSS 25/50 A / DSS 35 M iP	1,133 kg	-	1	1	132,00
8. HEPA filterset • Jeu de filtre HEPA – voor / pour DSS 35 H iP								Prijs per 2 st. • Prix par 2 pcs
EE 35310		4026851017598	DSS 35 H iP	1,140 kg	-	1	1	326,00
9. Set van 7 toebehoren • Set de 7 accessoires – voor / pour DSS 25/50 A / DSS 35 M iP								
EE 35315		4026851004888	DSS 25/50 A / DSS 35 M iP	1,475 kg	-	1	1	68,70
10. Zuigslang • Tuyau d'aspirateur 3,2 m – voor / pour DSS 25/50 A / DSS 35 M iP								
EE 35307		4026851007643	3,2 m - Ø 35 mm	0,500 kg	-	1	1	68,70
11. Slangaansluiting, machinezijde • Raccord de tuyau, côté de la machine – voor / pour DSS 25/50 A / DSS 35 M iP								
EE 353135		4026851010285	DSS 25/50 A / DSS 35 M iP	0,057 kg	-	1	1	23,70
12. Gereedschapsadapter • Adaptateur pour outil – voor / pour ESS 35 LP/ESS 35 MP Ø34-37mm								
EE 35670		4026851019066	ESS 35 LP/ESS 35 MP	0,040 kg	-	1	1	19,50