

19

GEREEDSCHAPPEN VOOR AFWERKING *OUTILS DE FINITION*

VOEGSPATELS
SCHILDERSMESSEN & -SPATELS
SPACKMESSEN
PLAASTERROLLEN
AFSCHRAAPGEREEDSCHAP
DIVERSE GEREEDSCHAPPEN
GEREEDSCHAP VOOR ISOLATIE
MENGSTANGEN
GEREEDSCHAP VOOR GIPSPLATEN
PLATENLIFT
SCHRAGEN
PLATENKAR

SPATULES
COUTEAUX & SPATULES DE PEINTRE
COUTEAUX À ENDUIRE
ROULEAUX À ENDUIT
OUTILS DE RACLAGE ET DÉCAPAGE
OUTILS DIVERS
OUTILS POUR ISOLATION
MÉLANGEURS
OUTILS DE PLAQUISTE
LÈVE-PLAQUES
TRÉTEAUX
CHARIOT PORTE-PLAQUES



TOP!



PENGUIN
EMPIRE SERIES



Voegspatel uit één deel met SOFT TOUCH handgreep en hamerkop - inox
Spatule à jointoyer en une pièce avec poignée SOFT TOUCH et tête marteau - inoxydable



code							min.	€
DS 07050	vrac	5420000067332	50 mm	0,114 kg	72	12	1	9,55
DS 07075	vrac	5420000067349	75 mm	0,130 kg	72	12	1	9,95
DS 07100	vrac	5420000067356	100 mm	0,136 kg	72	12	1	11,05
DS 07125	vrac	5420000067363	125 mm	0,154 kg	72	12	1	11,55
DS 07150	vrac	5420000067370	150 mm	0,166 kg	72	12	1	12,80
DS 07200	vrac	5420000070677	200 mm	0,190 kg	72	12	1	16,25
DS 07250	vrac	5420000070684	250 mm	0,220 kg	72	12	1	17,50

NYLON-HAMMERGRIP voegspatel - carbon staal
NYLON-HAMMERGRIP spatule à jointoyer - acier carbon

code							min.	€
DS 03100	vrac	5420000003385	150 mm	0,118 kg	192	12	1	13,12



DURA-HAMMERGRIP voegspatel met hamerkop - inox
DURA-HAMMERGRIP spatule à jointoyer avec tête marteau - inoxydable

code							min.	€
DS 04280	vrac	5420000003132	100 mm	0,144 kg	144	24	1	13,33
DS 04300	vrac	5420000003071	150 mm	0,160 kg	144	24	1	15,10
+ BIT								
DS 04809	vrac	5420000004849	150 mm	0,178 kg	144	12	1	15,79

DURA-HAMMERGRIP SK2 voegspatel, plamuurmes met hamerkop - inox
DURA-HAMMERGRIP SK2 spatule de peintre avec tête marteau - inoxydable

code							min.	€
DS 62080	vrac	5420000016699	100 mm	0,109 kg	144	12	1	6,69
DS 62090	vrac	5420000016705	125 mm	0,123 kg	144	12	1	7,78
DS 62100	vrac	5420000016712	150 mm	0,130 kg	144	12	1	8,41
DS 62110	vrac	5420000036710	200 mm	0,164 kg	144	12	1	14,74





WOOD-HAMMERGRIP voegspatel - inox
WOOD-HAMMERGRIP spatule à jointoyer - inoxydable

code							min.	€
DS 04600	vrac	5420000017030	150 mm	0,130 kg	192	12	1	15,31

DURA-GRIP schildersspatel, plamuurmes - inox
DURA-GRIP spatule de peintre - inoxydable

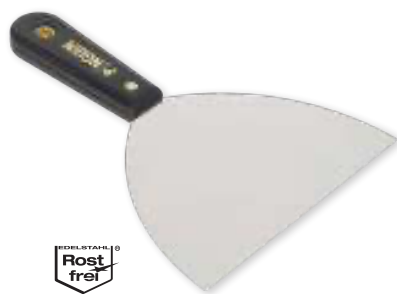
code							min.	€
DS 02220	vrac	5420000003408	32 mm	0,064 kg	288	12	1	4,69
DS 02240	vrac	5420000003415	50 mm	0,068 kg	288	12	1	5,10
DS 02260	vrac	5420000003422	75 mm	0,075 kg	288	12	1	6,52
DS 02280	vrac	5420000003439	100 mm	0,090 kg	192	12	1	7,58
DS 02290	vrac	5420000003446	125 mm	0,100 kg	192	12	1	8,77
DS 02300	vrac	5420000003392	150 mm	0,120 kg	192	12	1	10,71

NYLON-GRIP voegspatel - inox
NYLON-GRIP spatule à jointoyer - inoxydable

code							min.	€
DS 02080	vrac	5420000003514	100 mm	0,077 kg	192	24	1	7,46
DS 02090	vrac	5420000000872	125 mm	0,082 kg	192	24	1	8,69
DS 02100	vrac	5420000000889	150 mm	0,099 kg	192	24	1	9,95

Plaastervoegmes, vlak en gepunt
Fer de plâtrier, plat et pointu

code								min.	€
CP 159010-SB		4022307183534	10 mm	0,5 mm	0,032 kg	-	1	1	5,81
CP 159014-SB		4022307183541	14 mm	0,5 mm	0,036 kg	-	1	1	5,81
CP 159020-SB		4022307162027	20 mm	0,5 mm	0,043 kg	-	1	1	5,81
CP 159030-SB		4022307183558	30 mm	0,5 mm	0,058 kg	-	1	1	7,28

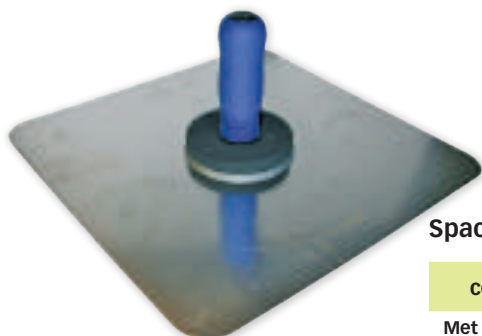
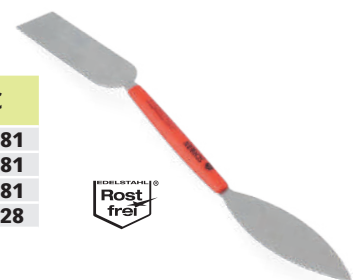
Spachtelbord in ALU • Palette de plâtrier en ALU

code							min.	€
DS 36950	vrac	5420000000940	330 x 330 mm	0,775 kg	24	6	1	33,70

Met ERGO-SOFT handgreep • Avec poignée ERGO-SOFT

**NEW**
Schildersmes uit één deel met hamerkop - inox
Couteau de peintre en une pièce avec tête marteau - inoxydable
PENGUIN
 EMPIRE SERIES

code							min.	€
DS 07350	vrac	5420000076532	50 mm	0,200 kg	72	12	1	12,17
DS 07375	vrac	5420000076549	75 mm	0,210 kg	72	12	1	12,93
DS 07400	vrac	5420000076556	100 mm	0,220 kg	72	12	1	13,79

TOPFLEX flexibel schildersmes - inox
TOPFLEX couteau de peintre à lame flexible - inoxydable

code							min.	€
DS 05210	vrac	5420000011151	25 mm	0,075 kg	144	24	1	9,80
DS 05230	vrac	5420000011168	38 mm	0,082 kg	144	24	1	9,98
DS 05240	vrac	5420000011175	50 mm	0,086 kg	144	24	1	10,85
DS 05250	vrac	5420000011182	63 mm	0,089 kg	144	24	1	11,22
DS 05260	vrac	5420000011250	75 mm	0,093 kg	144	24	1	11,52
DS 05280	vrac	5420000013919	100 mm	0,099 kg	144	24	1	13,07

Gesmeed uit 1 deel • forgé monobloc

UNI-GRIP schildersmes - inox
UNI-GRIP couteau de peintre - inoxydable

code							min.	€
DS 08020	vrac	5420000003156	32 mm	0,052 kg	192	24	1	3,25
DS 08030	vrac	5420000003163	40 mm	0,057 kg	192	24	1	3,80
DS 08040	vrac	5420000003170	50 mm	0,060 kg	192	24	1	4,10
DS 08050	vrac	5420000003187	60 mm	0,064 kg	192	24	1	4,52
DS 08060	vrac	5420000003194	80 mm	0,071 kg	192	24	1	5,41
DS 08080	vrac	5420000003200	100 mm	0,080 kg	192	24	1	6,58
DS 08090	vrac	5420000003217	125 mm	0,084 kg	144	24	1	7,71

Plamuurmes houten greep - staal verchroomd
Couteau de peintre, manche bois - acier chromé

code							min.	€
MB 102020	vrac	5420000012493	20 mm	0,042 kg	120	12	1	1,86
MB 102030	vrac	5420000012509	30 mm	0,048 kg	120	12	1	2,18
MB 102040	vrac	5420000012516	40 mm	0,050 kg	120	12	1	2,28
MB 102050	vrac	5420000012523	50 mm	0,052 kg	120	12	1	2,40
MB 102060	vrac	5420000012530	60 mm	0,054 kg	120	12	1	2,53
MB 102080	vrac	5420000012547	80 mm	0,058 kg	120	12	1	2,99
MB 102100	vrac	5420000012554	100 mm	0,072 kg	120	12	1	3,51
MB 102120	vrac	5420000012561	120 mm	0,090 kg	120	12	1	4,14

Japane spatelset, 4-delig • Jeu de 4 couteaux Japonais

code							min.	€
Staal • Acier								
PL 606404		5420000000063	50, 80, 100, 120 mm	0,100 kg	-	100	1	1,99
Inox • Inoxydable								
CP 606604		4022307158242	50, 80, 100, 120 mm	0,104 kg	-	100	1	5,76

Emmerspatel, kurk Soft grip - inox
Couteau à seau, manche en liège Soft-grip - inoxydable

PINGUIN
 EMPIRE SERIES

code							min.	€
DS 35016	vrac	5420000067820	160 mm	0,210 kg	-	10	1	14,75

Schildersspatel soft greep - inox
Couteau à enduire, manche soft - inoxydable

code							min.	€
MB 26001	vrac	5420000023260	100 mm	0,094 kg	120	5	1	6,60
MB 26002	vrac	5420000023277	120 mm	0,104 kg	120	5	1	6,93
MB 26003	vrac	5420000023284	140 mm	0,117 kg	120	5	1	7,41
MB 26004	vrac	5420000023291	160 mm	0,130 kg	90	5	1	7,65
MB 26005	vrac	5420000023307	180 mm	0,152 kg	90	5	1	8,07
MB 26006	vrac	5420000023314	200 mm	0,164 kg	90	5	1	8,59

Schildersspatel houten greep - staal
Couteau à enduire, manche bois - acier

code							min.	€
MB 160120	vrac	5420000012424	120 mm	0,126 kg	30	5	1	4,30
MB 160140	vrac	5420000012431	140 mm	0,137 kg	30	5	1	4,67
MB 160160	vrac	5420000012448	160 mm	0,144 kg	30	5	1	5,13
MB 160180	vrac	5420000012455	180 mm	0,180 kg	30	5	1	5,44
MB 160200	vrac	5420000012462	200 mm	0,195 kg	30	5	1	6,60
MB 160240	vrac	5420000012479	240 mm	0,202 kg	30	5	1	7,12

ERGO-SOFT breedspatel - inox
ERGO-SOFT couteau à enduire - inoxydable

code							min.	€
DS 36061	vrac	5420000003538	200 mm	0,246 kg	72	12	1	11,60
DS 36062	vrac	5420000003545	250 mm	0,289 kg	72	12	1	13,07
DS 36063	vrac	5420000003552	300 mm	0,318 kg	72	12	1	14,67
DS 36064	vrac	5420000018396	350 mm	0,348 kg	72	12	1	17,35

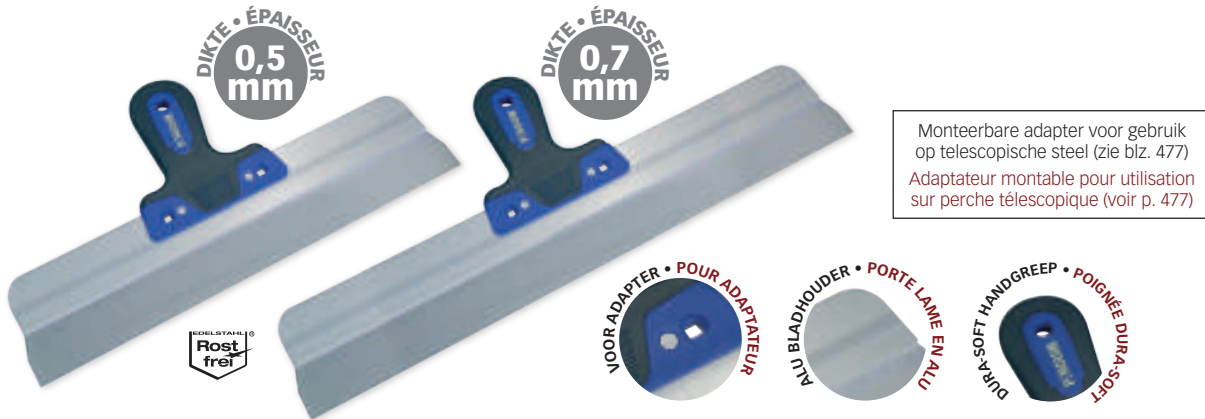

Monteerbare adapter voor gebruik op telescopische steel (zie blz. 477)
Adaptateur montable pour utilisation sur perche télescopique (voir p. 477)

Spackmes met DURA-SOFT greep - inox blad Couteau à enduire avec manche DURA-SOFT - lame inoxydable



code										min.	€
Flexibel • Flexible											
DS 008020	vrac	5420000012370	200 mm	0,5 mm	0,240 kg	600	60	10	1		8,71
DS 008028	vrac	5420000001190	300 mm	0,5 mm	0,315 kg	720	60	10	1		10,17
DS 008038	vrac	5420000001206	400 mm	0,5 mm	0,377 kg	660	60	10	1		12,19
DS 008048	vrac	5420000001213	500 mm	0,5 mm	0,447 kg	480	60	10	1		14,09
DS 008057	vrac	5420000001220	600 mm	0,5 mm	0,507 kg	360	60	10	1		16,09
Stijf blad • Lame rigide											
DS 008938	vrac	5420000017054	400 mm	0,7 mm	0,414 kg	600	60	10	1		13,22
DS 008948	vrac	5420000003095	500 mm	0,7 mm	0,492 kg	480	60	10	1		14,94
DS 008960	vrac	5420000017061	600 mm	0,7 mm	0,554 kg	360	60	10	1		16,62

ALU basis • Support ALU

Monteerbare adapter voor gebruik op telescopische steel (zie blz. 477)
Adaptateur montable pour utilisation sur perche télescopique (voir p. 477)



Spackmes met DURA-SOFT greep, met tanding 6x6 mm - inox Couteau à enduire avec manche DURA-SOFT, avec denture 6x6 mm - inoxydable

code										min.	€
DS 004906	vrac	5420000042964	500 mm	0,7 mm	0,444 kg	-	10	1			17,46



DIKTE • ÉPAISSEUR
0,4 mm



DS 002820

Monteerbare adapter voor gebruik op telescopische steel (zie blz. 477)
Adaptateur montable pour utilisation sur perche télescopique (voir p. 477)



DS 002840

Spackmes met ergonomische handgreep in SOFT-GRIP - inox blad
Couteau à enduire avec poignée ergonomique en SOFT-GRIP - lame inoxydable

code								min.	€
DS 002820	vrac	5420000067837	200 mm	0,4 mm	0,200 kg	-	10	1	9,00
DS 002830	vrac	5420000067844	300 mm	0,4 mm	0,265 kg	-	10	1	10,19
DS 002840	vrac	5420000067851	400 mm	0,4 mm	0,324 kg	-	10	1	12,19
DS 002850	vrac	5420000067868	500 mm	0,4 mm	0,378 kg	-	10	1	13,17
DS 002860	vrac	5420000067875	600 mm	0,4 mm	0,437 kg	-	10	1	15,28



Kofferinhoud / Contenu du coffre

- Voegspatels • Spatules à jointoyer**
- DS 07050 • 50 mm **1X**
 - DS 07075 • 75 mm **1X**
 - DS 07150 • 150 mm **1X**
- Spackmessen • Couteaux à enduire**
- DS 002820 • 200 x 0,65 mm **1X**
 - DS 002830 • 300 x 0,65 mm **1X**
 - DS 002860 • 600 x 0,65 mm **1X**
- Plaasterspanen • Plâtres**
- DS 704130 • 305 x 120 x 0,65 mm **1X**
 - DS 705228 • 280 x 100 x 0,30 mm **1X**



SET : EMPIRE SERIES BLACK

code							min.	€
DS 002899-SET	koffer/coffre	5420000068506	8-delig / 8 pièces	3,982 kg	-	1	1	194,00



DS 003530

VLAKKE HANDGREEP
POIGNÉE PLATE

Spackmes met ergonomische vlakke handgreep in KURK - inox blad
Couteau à enduire avec poignée ergonomique plate en LIÈGE - lame inoxydable

code								min.	€
DS 003530	vrac	5420000067677	300 mm	0,4 mm	0,270 kg	-	10	1	12,14
DS 003540	vrac	5420000067684	400 mm	0,4 mm	0,340 kg	-	10	1	14,25
DS 003550	vrac	5420000067691	500 mm	0,4 mm	0,390 kg	-	10	1	16,36
DS 003560	vrac	5420000067707	600 mm	0,4 mm	0,445 kg	-	10	1	18,62
DS 003580	vrac	5420000067714	800 mm	0,4 mm	0,580 kg	-	10	1	19,81

DIKTE • ÉPAISSEUR
0,4 mm

Monteerbare adapter voor gebruik op telescopische steel (zie blz. 477)
Adaptateur montable pour utilisation sur perche télescopique (voir p. 477)



DS 002641

AFGERONDE HANDGREEP
POIGNÉE ARRONDIE

DIKTE • ÉPAISSEUR
0,4 mm

Spackmes met ergonomische afgeronde handgreep in KURK - inox blad
Couteau à enduire avec poignée ergonomique arrondie en LIÈGE - lame inoxydable

code								min.	€
DS 002631	vrac	5420000067721	300 mm	0,4 mm	0,270 kg	-	10	1	12,40
DS 002641	vrac	5420000067738	400 mm	0,4 mm	0,350 kg	-	10	1	14,46
DS 002651	vrac	5420000067745	500 mm	0,4 mm	0,395 kg	-	10	1	16,26
DS 002661	vrac	5420000067752	600 mm	0,4 mm	0,450 kg	-	10	1	19,35
DS 002681	vrac	5420000067769	800 mm	0,4 mm	0,600 kg	-	10	1	22,64

Kofferinhoud / Contenu du coffre

Voegspatels • Spatules à jointoyer

DS 07050 • 50 mm	1x
DS 07075 • 75 mm	1x
DS 07150 • 150 mm	1x

Spackmessen • Couteaux à enduire

DS 002631 • 300 x 0,40 mm	1x
DS 002641 • 400 x 0,40 mm	1x
DS 002661 • 600 x 0,40 mm	1x

Plaasterspaan • Plâtresse

DS 703030 • 305 x 120 x 0,65 mm	1x
---------------------------------	----

Emmerspatel • Couteau à seau

DS 35016	1x
----------	----



SET : EMPIRE SERIES CORK

code								min.	€
DS 002699-SET	koffer/coffre	5420000068513	8-delig / 8 pièces	4,030 kg	-	1	1	1	180,00



HOUTBLADHOUDER • PORTE LAME EN BOIS

HOUTLEN HANDGREP • POIGNÉE EN BOIS



EDELSTAHL®
Rost
frei

DIKTE • ÉPAISSEUR
0,7 mm

Monteerbare adapter voor gebruik op telescopische steel (zie blz. 477)
Adaptateur montable pour utilisation sur perche télescopique (voir p. 477)

Spackmes met houten greep - inox blad
Couteau à enduire, manche bois - lame inoxydable

code								min.	€
DS 004540	vrac	5420000042933	400 mm	0,7 mm	0,274 kg	-	10	1	9,59
DS 004650	vrac	5420000042940	500 mm	0,7 mm	0,398 kg	-	10	1	11,08
DS 004860	vrac	5420000042957	600 mm	0,7 mm	0,471 kg	-	10	1	13,53

Adapters en telescoopstangen voor PINGUIN spackmessen
Adaptateurs et perches télescopique pour couteaux à enduire PINGUIN

code							min.	€
Telescoopstang (standaard - inclusief adapter verf- of plaasterrol) Perche télescopique (standard - adaptateur rouleau à peinture ou à plâtre inclus)								
DS 009150	vrac	5420000071063	100 → 230 cm	0,750 kg	-	24	1	17,60
Telescopische steel (alu + fiber) Manche télescopique (alu + fibre)								
MB 572001	vrac	5420000067516	73 → 120 cm	0,450 kg	-	3	1	30,40
MB 572002	vrac	5420000067523	120 → 220 cm	0,600 kg	-	3	1	37,20
Euro adapter (geschikt voor alle PINGUIN spackmessen) Adaptateur Euro (convient à tous les couteaux à enduire PINGUIN)								
DS 009275		5420000035690	-	0,111 kg	-	12	1	4,67
DUO adapter • Adaptateur DUO								
DS 009305		5420000068667	A + B	0,075 kg	-	30	1	6,00

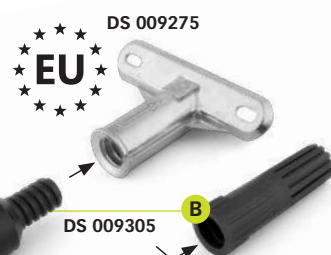

Met de **DUO adapter (DS 009305)** kan u via de schroefdraad de Euro adapter (DS 009275) monteren, maar ook een adapter voor een verf- of plaaster rol. Deze adapter bestaat uit twee stukken **A** en **B**.

Avec l'**adaptateur DUO (DS 009305)**, vous pouvez monter l'adaptateur Euro (DS 009275) via le pas de vis, mais également un adaptateur pour un rouleau à peinture ou à plâtre. Cet adaptateur se compose de deux pièces **A** et **B**.

new design

MB 572001
MB 572002

DS 009150



TOP!



MB 541060

DIKTE • ÉPAISSEUR
0,3 mm

Spackmes FLEXO-LITE GOLD - inox chrom blad
Couteau à enduire FLEXO-LITE GOLD - lame chromé inoxydable

code								min.	€
MB 541015		5420000069145	150 mm	0,3 mm	0,170 kg	-	12	1	20,34
MB 541020		5420000069152	200 mm	0,3 mm	0,240 kg	-	12	1	20,76
MB 541030		5420000069169	300 mm	0,3 mm	0,380 kg	-	12	1	26,20
MB 541040		5420000069176	400 mm	0,3 mm	0,520 kg	-	12	1	31,55
MB 541060		5420000069183	600 mm	0,3 mm	0,810 kg	-	12	1	45,30
MB 541080		5420000069190	800 mm	0,3 mm	1,100 kg	-	12	1	58,20
MB 541100		5420000069206	1000 mm	0,3 mm	1,380 kg	-	6	1	70,10
Adapter voor telescopische steel • Adaptateur pour manche télescopique									
MB 541555		5420000069213	-	-	0,270 kg	-	10	1	13,97
Telescopische steel (alu + fiber) • Manche télescopique (alu + fibre)									
MB 572001	vrac	5420000067516	73 → 120 cm		0,450 kg	-	3	1	30,40
MB 572002	vrac	5420000067523	120 → 220 cm		0,600 kg	-	3	1	37,20
Vervangblad • Lame de rechange									
● MB 542041		5420000074958	400 mm	0,3 mm	0,060 kg	-	10	1	16,65
● MB 542061		5420000074927	600 mm	0,3 mm	0,120 kg	-	10	1	22,50
● MB 542081		5420000074934	800 mm	0,3 mm	0,160 kg	-	10	1	27,23
● MB 542101		5420000074941	1000 mm	0,3 mm	0,200 kg	-	10	1	34,30



MB 541555



MB 572002



Kofferinhoud / Contenu du coffre

Voegspatels • Spatules à jointoyer

DS 07050 • 50 mm	1x
DS 07075 • 75 mm	1x
DS 07100 • 100 mm	1x
DS 07125 • 125 mm	1x
DS 07150 • 150 mm	1x
DS 07555 • 6-in-1 / 75 mm	1x

Spackmessen • Couteaux à enduire

MB 541020 • 200 x 0,30 mm	1x
MB 541030 • 300 x 0,30 mm	1x
MB 541060 • 600 x 0,30 mm	1x

Steel + adapter • Manche + adaptateur

MB 572001 • 73 → 120 cm	1x
MB 541555	1x



new design

new design

SET : EMPIRE SERIES FLEXO-LITE GOLD

code							min.	€
MB 541995-SET	koffer/coffre	5420000069220	11-delig / 11 pièces	4,610 kg	-	1	1	248,00



DIKTE • ÉPAISSEUR
0,3 mm



Spackmes ERGOFLEX met ergonomische handgreep - inox blad
Couteau à enduire ERGOFLEX avec poignée ergonomique - lame inoxydable

code								min.	€
MB 550220		5420000067547	200 mm	0,3 mm	0,210 kg	-	1	1	17,87
MB 550230		5420000067554	300 mm	0,3 mm	0,280 kg	-	1	1	21,38
MB 550240		5420000067561	400 mm	0,3 mm	0,420 kg	-	1	1	25,62
MB 550260		5420000067585	600 mm	0,3 mm	0,680 kg	-	1	1	35,65
MB 550280		5420000067592	800 mm	0,3 mm	0,700 kg	-	1	1	43,60
Adapter voor telescopische steel • Adaptateur pour manche télescopique									
MB 571990		5420000067608	-	-	0,250 kg	-	10	1	17,66
Telescopische steel (alu + fiber) • Manche télescopique (alu + fibre)									
MB 572001	vrac	5420000067516	73 → 120 cm		0,450 kg	-	3	1	30,40
MB 572002	vrac	5420000067523	120 → 220 cm		0,600 kg	-	3	1	37,20

MB 550260



MB 571990



MB 572002

new design



Kofferinhoud / Contenu du coffre

Voegspatels • Spatules à jointoyer

DS 07050 • 50 mm	1X
DS 07075 • 75 mm	1X
DS 07100 • 100 mm	1X
DS 07125 • 125 mm	1X
DS 07150 • 150 mm	1X
DS 07555 • 6-in-1 / 75 mm	1X

Spackmessen • Couteaux à enduire

MB 550220 • 200 x 0,30 mm	1X
MB 550230 • 300 x 0,30 mm	1X
MB 550260 • 600 x 0,30 mm	1X

Steel + adapter • Manche + adaptateur

MB 572001 • 73 → 120 cm	1X
MB 571990	1X



new design

SET : EMPIRE SERIES ERGOFLEX

code							min.	€
MB 550990-SET	koffer/coffre	5420000068490	11-delig / 11 pièces	4,614 kg	-	1	1	233,00



MB 355240

DIKTE • ÉPAISSEUR
0,3 mm



Spackmes FINISH SOFT - inox blad (gehard)
Couteau à enduire FINISH SOFT - lame inoxydable (trempée)

code								min.	€
MB 355220		5420000069800	200 mm	0,3 mm	0,171 kg	-	12	1	18,29
MB 355230		5420000069817	300 mm	0,3 mm	0,283 kg	-	12	1	23,12
MB 355240		5420000069824	400 mm	0,3 mm	0,395 kg	-	12	1	26,10
MB 355260		5420000069831	600 mm	0,3 mm	0,619 kg	-	12	1	35,45
MB 355280		5420000069848	800 mm	0,3 mm	0,843 kg	-	12	1	42,75



MB 541555



Adapter voor telescopische steel • Adaptateur pour manche télescopique

MB 541555		5420000069213	-	-	0,270 kg	-	10	1	13,97
-----------	--	---------------	---	---	----------	---	----	---	--------------

Telescopische steel (alu + fiber) • Manche télescopique (alu + fibre)

MB 572001	vrac	5420000067516	73 → 120 cm		0,450 kg	-	3	1	30,40
MB 572002	vrac	5420000067523	120 → 220 cm		0,600 kg	-	3	1	37,20



MB 572002

new design

Spackmes met houten greep - inox
Couteau à enduire, manche bois - inoxydable

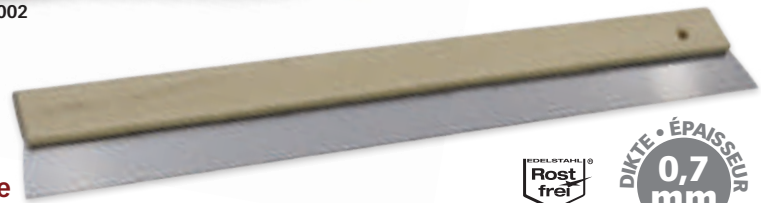

DIKTE • ÉPAISSEUR
0,7 mm

code								min.	€
DS 005800	vrac	5420000024489	800 mm	0,7 mm	0,706 kg	-	100	1	29,31



Spackmes ALU profiel XXL met vervangbaar blad
Couteau à enduire ALU profile XXL avec lame interchangeable



CP 292210

DIKTE • ÉPAISSEUR
0,5 mm

code								min.	€
CP 292210	vrac	4022307177540	1000 mm	0,5 mm	2,100 kg	-	1	1	81,60
Vervangblad • lame de rechange									Per 5 st • Par 5 pcs
CP 292305		4022307178158	1000 mm	0,5 mm	0,450 kg	-	1	1	56,80



CP 292305

Gipsmes met houten greep, stijf blad - staal
Couteau de plâtrier, monture bois, lame rigide - acier

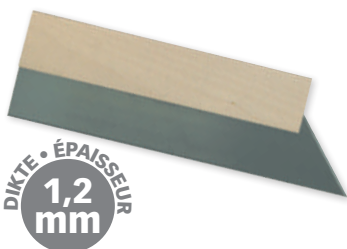

DIKTE • ÉPAISSEUR
1,2 mm

code								min.	€
CP 314130	vrac	4022307118123	300 mm	1,2 mm	0,233 kg	-	10	1	15,17
CP 314140	vrac	4022307118130	400 mm	1,2 mm	0,320 kg	-	10	1	20,20
CP 314150	vrac	4022307118154	500 mm	1,2 mm	0,418 kg	-	10	1	23,23



Plasterrol compleet - PP handgreep
Rouleau à enduit complet - poignée PP

code			cap.			min.	€
		mm					
DS 050080	vrac	5420000070714	80	11 m ²	0,220 kg	- 50	1 9,57
DS 050180	vrac	5420000068629	180	25 m ²	0,306 kg	- 50	1 11,33
DS 050250	vrac	5420000070691	250	34 m ²	0,410 kg	- 30	1 16,11
Vervangrol "Plaster" - 18 mm • Manchon de rechange "Enduit" - 18 mm							
DS 050081	vrac	5420000070721	80	11 m ²	0,059 kg	- 70	1 5,76
DS 051181	vrac	5420000068636	180	25 m ²	0,100 kg	- 80	1 9,06
DS 051251	vrac	5420000070707	250	34 m ²	0,141 kg	- 50	1 11,46

✓ Nylonvezel met hoge veerkracht
Fibre nylon avec résilience

✓ 3x sneller
3x plus rapide



VOOR HOEKEN • POUR ANGLES

Plasterrol voor hoeken compleet - PP handgreep
Rouleau à enduit pour angles complet - poignée PP



code						min.	€
		mm					
DS 050020	vrac	5420000070738	20	0,205 kg	- 50	1 25,11	

DURA-GRIP multifunctioneel mes - inox
DURA-GRIP couteau multifonction - inoxydable

code							min.	€
DS 02340	vrac	5420000003460	63 mm	0,098 kg	144	12	1	6,52

DURA-HAMMERGRIP multifunctioneel mes met hamerkop - inox
DURA-HAMMERGRIP couteau multifonction avec tête marteau - inoxydable

code							min.	€
DS 61160	vrac	5420000011199	75 mm	0,133 kg	144	12	1	10,80

MULTI-TOOL spatel uit één deel met SOFT TOUCH handgreep en hamerkop - inox
Spatule MULTI-TOOL en une pièce avec poignée SOFT TOUCH et tête marteau - inoxydable

code							min.	€
DS 07555	vrac	5420000067530	75 mm	0,158 kg	72	12	1	13,25

PENGUIN
EMPIRE SERIES

DURA-HAMMERGRIP afsteekmes met stijf blad, met hamerkop - inox
DURA-HAMMERGRIP riflard à lame rigide, avec tête marteau - inoxydable

code							min.	€
DS 62041	vrac	5420000011205	50 mm	0,104 kg	144	12	1	5,96
DS 62061	vrac	5420000011212	75 mm	0,124 kg	144	12	1	7,15

FLEXIBEL • FLEXIBLE

- OXIDEERT NIET / NE S'OXYDE PAS
- BLIJFT SCHERP / RESTE TRANCHANT
- GESCHIKT VOOR HET BEWERKEN VAN KWETSBARE OPPERVLAKKEN
CONVIENT POUR TRAVAILLER SUR DES SURFACES SENSIBLES

Afschraper SOFT-GRIP met polyamide en glasvezel blad
Grattoir SOFT-GRIP avec lame en polyamide et fibre de verre

code							min.	€
DS 63445	vrac	5420000069916	45 mm	0,040 kg	-	12	1	4,13
DS 63460	vrac	5420000069923	60 mm	0,045 kg	-	12	1	4,29
DS 63490	vrac	5420000069930	90 mm	0,055 kg	-	12	1	4,55

Afgeschuind blad
Lame biseautée



Beitelmes met hamerkop
Ciseau avec tête à frappe



code								min.	€
TJ SCRC50		4975364017970	50 mm	1,8 mm	0,188 kg	-	12	1	23,29

Visstaart vorm • **Forme trapèze**

TJ SCRN95		4975364018007	95 mm	1,8 mm	0,204 kg	-	12	1	23,29
-----------	--	---------------	-------	--------	----------	---	----	---	-------

Multivorm • **Multiforme**

TJ SCRM75		4975364018021	75 mm	1,8 mm	0,184 kg	-	12	1	23,29
-----------	--	---------------	-------	--------	----------	---	----	---	-------



Afschraper/beitel - Flexibel lemmet
Grattoir/burin - lame flexible

Tajima

code							min.	€
TJ PHR250F80		4975364058065	280 x 80 mm	0,360 kg	-	6	1	45,45
Flexibel vervanglemmet • Lame de rechange flexible								
TJ PHR-FB80		4975364058089	80 x 0,5 mm	0,050 kg	-	1	1	7,06

DIKTE • ÉPAISSEUR
0,5 mm

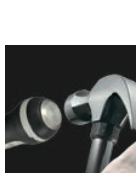

Afschraper/beitel met hamerkop - Extra hard lemmet
Grattoir/burin avec tête marteau - lame extra rigide

Tajima

code							min.	€
TJ PHR250H80		4975364058041	285 x 80 mm	0,435 kg	-	6	1	51,50
TJ PHR500H80		4975364058058	565 x 80 mm	0,610 kg	-	6	1	60,50
Extra hard vervanglemmet • Lame de rechange extra rigide								
TJ PHR-HB80		4975364058072	80 x 1,2 mm	0,085 kg	-	1	1	11,29

DIKTE • ÉPAISSEUR
1,2 mm



incl. 3 x

Afschraper Rite-P met vervangbaar lemmet
Grattoir Rite-P avec lame interchangeable

Tajima

code							min.	€
TJ PSCL300F		4975364058034	305 mm 18 mm	0,430 kg	-	6	1	48,55
Vervanglemmets • Lames de recharges								
TJ LCB50		4975364014276	18 x 0,50 mm	0,090 kg	120	10	10	5,22

Per 10 st • Par 10 pcs



Tajima

TJ SCRL600

TJ SCRL300

incl. 3 x



Afschraper met omkeerbaar lemmet, hamerkop en verstevigde steel
Grattoir avec lame réversible, tête marteau et manche renforcé

code							min.	€	
TJ SCRL300		4975364016133	300 mm	18 mm	0,380 kg	-	4	1	30,75
TJ SCRL600		4975364016140	600 mm	18 mm	0,558 kg	-	4	1	38,40
TJ SCRH1200		4975364019967	1200 mm	25 mm	1,215 kg	-	4	1	52,40

Vervanglemmets voor Tajima afschraper
Lames de rechange pour grattoir Tajima

Tajima

code							min.	€	
TJ LCB50		4975364014276	afmetingen dimensions	# secties # section					
TJ LCB65		4975364020888	18 x 0,50 mm	8	0,090 kg	3360	120	10	5,22
			25 x 0,70 mm	7	0,204 kg	3000	60	10	12,06

Per 10 st • Par 10 pcs

Universele afschraper met vervangbaar lemmet en hamerkop
Grattoir universel avec lame interchangeable et tête marteau

ALU **SOFT GRIP**

SK2

incl. 1 x

code							min.	€
FC 620030		5420000075757	290 x 108 mm	0,363 kg	32	8	1	11,50
FC 620040		5420000075764	390 x 108 mm	0,375 kg	32	8	1	12,75
Vervanglemmets • Lames de rechanges								Per 10 st • Par 10 pcs
FC 620195		5420000075771	100 x 17,5 mm	0,020 kg	120	10	1	2,25



FC 620195

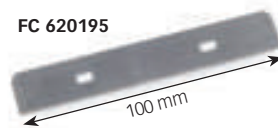

DIKTE • ÉPAISSEUR
0,65 mm



FC 620030



FC 615100

Universele afschraper met vervangbaar lemmet
Grattoir universel avec lame interchangeable

PVC GRIP

SK5

incl. 1 x

code							min.	€
FC 615100		5420000012011	300 x 100 mm	0,226 kg	120	20	1	7,86
FC 615150		5420000012035	600 x 150 mm	0,470 kg	48	12	1	13,10
Vervanglemmets • Lames de rechanges								Per 10 st • Par 10 pcs
FC 615101		5420000012028	100 mm	0,066 kg	200	25	1	3,43
Vervanglemmets • Lames de rechanges								Per 5 st • Par 5 pcs
FC 615151		5420000012042	150 mm	0,162 kg	-	10	1	6,12



Universele afschraper - Bi-component met vervangbaar lemmet
Grattoir universel - Bi-matière avec lame interchangeable
SOFT GRIP
NEW
 DIKTE • ÉPAISSEUR
0,65 mm

code							min.	€
FC 607105		5420000075740	160 x 105 mm	0,078 kg	60	10	1	4,50
Vervanglemmets • Lames de rechanges								Per 10 st • Par 10 pcs
FC 620195		5420000075771	100 x 17,5 mm	0,020 kg	120	10	1	2,25

Glasschraper kunststof met vervangbaar lemmet
Grattoir pour verre plastique avec lame interchangeable
ABS
NEW

code							min.	€
FC 605000		5420000075795	172 x 71 mm	0,038 kg	144	12	12	1,10

Glasschraper zelfladend met vervangbaar lemmet
Grattoir verre auto-charge avec lame interchangeable
SOFT GRIP

code							min.	€
FC 606450		5420000075801	145 x 55 mm	0,094 kg	96	12	1	3,78
Vervanglemmets • Lames de rechanges								Per 5 st • Par 5 pcs
DS 38523		5420000014039	20 x 40 mm	0,019 kg	288	24	1	1,26

Metalen glasschraper met vervangbaar lemmet
Gratte vitres monture métallique avec lame interchangeable

code							min.	€
DS 38520		5420000012004	100 x 40 mm	0,056 kg	-	24	1	4,35
Vervanglemmets • Lames de rechanges								Per 5 st • Par 5 pcs
DS 38523		5420000014039	20 x 40 mm	0,019 kg	288	24	1	1,26





Handscraper alu steel met kunststof greep, vervangbaar lemmet (hardmetaal)
Racloir avec manche en alu et poignée en plastique, lame interchangeable (carbure de tungstène)

code							min.	€
Met driehoekig lemmet • Avec lame triangulaire								
FC 610025		542000012127	20 mm	0,178 kg	96	6	1	12,44
Met recht lemmet • Avec lame droite								
FC 610050		542000012134	50 mm	0,209 kg	-	6	1	16,38
Met recht lemmet + bol • Avec lame droite + boule								
FC 610060		542000012141	60 mm	0,276 kg	72	6	1	21,13
Vervanglemmets per stuk verpakt • Lames de rechanges emballées par pièce								
FC 610026		542000012158	20 mm	0,017 kg	240	10	1	6,87
FC 610051		542000012165	50 mm	0,020 kg	240	10	1	7,49
FC 610061		542000012172	60 mm	0,021 kg	240	10	1	11,84



Uitkapmes voor mastiek, PP greep - staal
Couteau à démastiquer, manche PP - acier

code							min.	€
MB 101870	vrac	542000012592	90 x 30 mm	0,067 kg	60	12	1	6,28



Multifunctioneel beitelmess
Couteau burin multifonction

code							min.	€
TJ DKTN80		4975364164018	mes / lame - 70 mm	166 gr	-	10	1	33,45

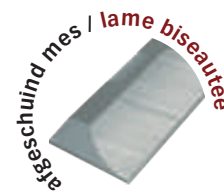

Verfschraper, houten greep • Grattoir à peinture, manche bois

code							min.	€
Met driehoekig lemmet • Avec lame triangulaire								
DS 06655	vrac	542000012363	60 mm	0,124 kg	144	12	1	5,96
Met multi-functioneel lemmet • Avec lame multi-forme								
DS 06650	vrac	542000011144	50 mm	0,132 kg	144	12	1	8,08

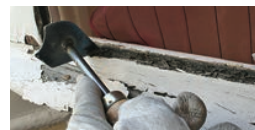

Mastiekmes laurierblad, houten greep - staal
Couteau à mastiquer feuille de laurier, manche bois - acier

code							min.	€
MB 101930	vrac	542000012585	110 x 35 mm	0,055 kg	120	12	1	3,12



Gladstrijkspatel PE trapeziumvorm
Spatule à maroufler forme trapèze en PE

code							min.	€
PL 521000	vrac	5420000012073	240 x 120 mm	0,064 kg	-	100	1	1,33

Gladstrijkspatel PE met ingewerkte handgreep
Spatule à maroufler en PE avec poignée incorporée

code							min.	€
PL 521777	vrac	5420000012066	255 x 130 mm	0,076 kg	-	60	1	2,01

Afsnijlat, kunststof basis - inox
Règle de coupe, monture PVC - inoxydable

code							min.	€
PL 520000	vrac	5420000012080	570 mm	0,234 kg	-	50	1	4,28

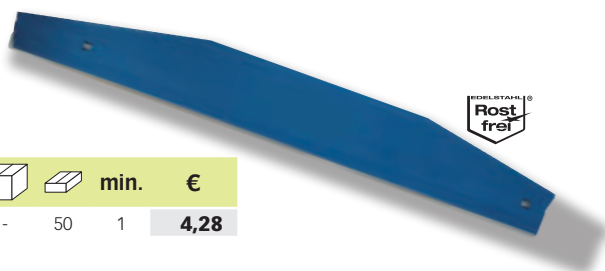
Behangerslat - inox • Règle de colleur - inoxydable

code							min.	€
PL 624020	vrac	5420000010529	6 cm x 2 m	0,382 kg	-	20	1	13,54
PL 624030	vrac	5420000010536	6 cm x 3 m	0,574 kg	-	20	1	17,97

19 GEREEDSCHAP VOOR AFWERKING OUTILS DE FINITIONS

DIVERSE GEREEDSCHAPPEN
OUTILS DIVERS



Rubberspatel voor het afdichten van inwendige hoeken van 60° tot 170°, hoekige, ronde en moeilijk toegankelijke gedeelten
Couteau à enduire caoutchouc pour enduire les angles intérieurs de 60° à 170°, les parties angulaires, arrondies et difficiles d'accès.



code							min.	€
ED 164055		3476060016409	60° → 170°	0,390 kg	-	12	1	18,93
Steel • Manche		L	Ø a	Ø b				
MS 8090	vrac	5420000010864	130 cm	20 mm	29 mm	0,505 kg	- 25 25	5,25



Gipsbeker - rubber • Bol à plâtre - caoutchouc



code							min.	€
Klein • Petit		Ø x H mm						
HH 614001	vrac	4039067119451	Ø 127 x 95 mm	0,070 kg	-	300	1	2,12
Groot • Grand		Ø x H mm						
PP 614100	vrac	5420000012899	Ø 160 x 100 mm	0,290 kg	-	40	1	7,37

Pannetje voor stukadoor • Casserole de plâtrier

code							min.	€
PL 637000	vrac	5420000015876	Ø 16 cm	0,334 kg	-	50	1	5,55



Gipserkom - PVC • Cuve à plâtre - PVC

code							min.	€
ED 066955	vrac	3476060006691	300 mm	0,270 kg	-	5	1	8,81



Crepimolen • Moulin à crépir

code							min.	€
PM 323331		5420000040212	260 x 160 mm	1,550 kg	-	6	1	32,25



Gipskam • Peigne à plâtre

code							min.	€
Met houten handgreep • Avec poignée en bois								
DS 30300	vrac	5420000042971	300 mm	0,256 kg	-	10	1	20,08



Hoekhouder voor cellenbeton
Equerre d'angle pour beton cellulaire

code							min.	€
TO 19500	vrac	5420000058736	255 x 255 x 265 mm	1,220 kg	-	1	1	26,57

Sleuventrekker voor cellenbeton
Rainreuse manuelle pour beton cellulaire

code							min.	€
TO 19760	vrac	5420000058743	570 mm	0,636 kg	-	1	1	17,80

Gipsschaaf ALU - 8 messen - Geschikt voor gips en gasbeton
Rabot à plâtre ALU - 8 lames - Adapté au plâtre et au béton cellulaire

code							min.	€
KU 353000	vrac	5420000012721	450 x 90 mm	0,684 kg	-	20	1	21,50
PL 353010	vrac	5420000035812	460 x 89 mm	0,967 kg	-	25	1	35,70

Hoekschaaf, houten greep - 6 messen
Rabot à plâtre, manche en bois - 6 lames

code							min.	€
CP 355034	vrac	4022307120300	340 x 40 mm	0,414 kg	-	15	1	29,67

Plafondzaag • Scie de plafond

code							min.	€
CP 354032	vrac	4022307120294	320 mm	0,082 kg	-	40	1	25,36

Gipsrooster rechthoekig
Grille, rabot à plâtre rectangulaire

code							min.	€
KU 25272	vrac	5420000010895	290 x 140 mm	0,784 kg	-	6	1	14,84

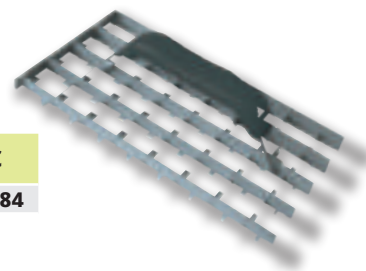



Kunststofspaan met rasp voor Styrofoam
Plâtoir plastique avec rape métallique pour Styrofoam

code							min.	€
Met vervangbaar blad • Avec lame remplaçable								
PL 108127	vrac	5420000034228	275 x 125 mm	0,365 kg	-	15	1	7,60
PL 108135	vrac	5420000034211	350 x 150 mm	0,550 kg	-	15	1	11,98
Met vast blad • Avec lame fixe								
PL 108380	vrac	5420000062542	380 x 160 mm	0,750 kg	-	15	1	12,40

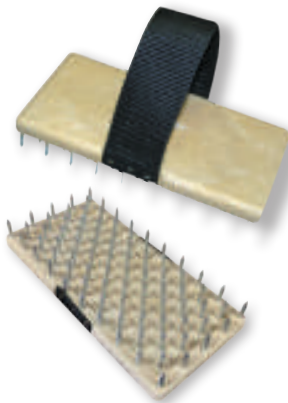

Krabblok kunststof, met riem
Taloche à pointes, poignée sangle

code							min.	€
PL 308018	vrac	5420000000995	180 x 90 mm	0,234 kg	-	10	1	9,30

Krabbord, doorgezette plaat • Taloche gratton, tôle emboutie

code				#					min.	€
Houten handgreep, lange punten • Poignée en bois, pointes longues										
CP 379200	vrac	4022307161860	255 x 155 mm	240	8,5 mm	0,488 kg	-	60	1	11,69
RM 321200	vrac	3479133212005	240 x 140 mm	240	15 mm	0,445 kg	-	6	1	14,26
RM 321210	vrac	3479133212104	250 x 150 mm	480	8 mm	0,380 kg	-	6	1	9,14

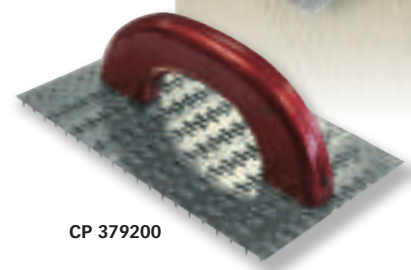
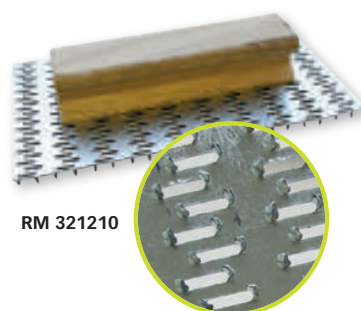
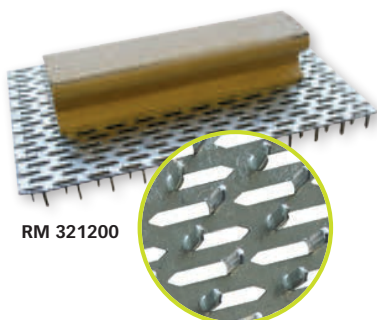

ED 366755

"STARTER KIT"
Toebehoren incl:

- Staalborstel
- Montagesleutel
- 1 blad 200 mm

Accessoires incl:

- Brosse métallique
- Clé de montage
- 1 lame 200 mm

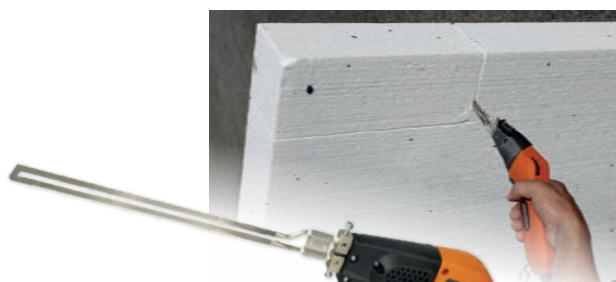

CE

EDMAFOAM Polystyreen snijder
EDMAFOAM Couteau thermique pour polystyrène

code							min.	€
ED 366755	koffer/coffre	3476060036674	320 W + 1 blad/lame	1,284 kg	-	1	1	205,00
Vervangblad - Lame de rechange								
ED 466755	vrac	3476060046673	200 mm	0,042 kg	-	1	1	47,00
ED 536750	vrac	3476065367506	250 mm	0,042 kg	-	1	1	70,10



ED 466755



ED 466455



ED 466555

Toebehoren voor EDMA polystyreen snijder
Accessoires pour couteau thermique polystyrène EDMA

code							min.	€
Perforator voor isolatie • Perforateur pour polystyrène								
ED 466455	vrac	3476060046642	D/P min. 25 - max. Ø 70 mm	0,095 kg	-	1	1	53,40
Sleuvenmaker voor isolatie • Rainreuse pour polystyrène								
ED 466555	vrac	3476060046659	Ø 30 mm	0,105 kg	-	1	1	64,20

Snijhoogte
Hauteur de coupe max. 630 mm

Snijdiepte
Profondeur de coupe max. 310 mm

Verstelbare lineaire geleider voor schuine zaagsnedes
Guidage linéaire orientable pour des coupes en angles 0° → 45°

Batterij
Batterie 18 V - 2 Ah Lithium

Inclusief toebehoren :

- Transportkoffer
- Batterij + batterijlader
- 3 snijdraden

- Accessoires inclus :**
- Coffre de transport
 - Batterie + chargeur de batterie
 - 3 fils de coupe

STYROGUN - Verwarmde draadsnijder voor polystyreen op batterij
STYROGUN - Découpeuse au fil chaud sur batterie pour polystyrène

CE

code							min.	€
ED 368455	koffer/coffre	3476063684551	H max. 630 mm D/P max. 310 mm	1,800 kg	-	1	1	749,00



Inclusief toebehoren :

- Transportkoffer
- 2 rollen snijdraad





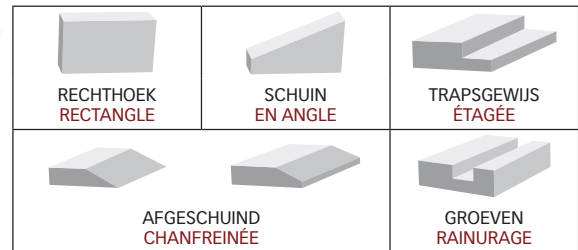

Accessoires inclus :

- Coffre de transport
- 2 bobines de fil de coupe

Snijlengte Longueur de coupe	max. 1400 mm
Snijdiepte Profondeur de coupe	max. 320 mm
Hoeksneede Coupe à angle	0° → 90°
Schuine snede Coupe biseautée	90° → 15°
Temp. snijdraad Temp. fil chaud	350°
Transformator Transformateur	42V / 240W / 230V
IP-klasse Classification IP	IP 65



Tafelzaag met verwarmde snijdraad voor polystyreen
Table de découpe avec fil chaud pour polystyrène

code							min.	€
ED 367155	koffer/coffre	3476063671551	H max. 1400 mm D/P max. 320 mm	29,300 kg	-	1	1	1174,00
Draadspoel • Bobine de fil								
ED 367455	zakje/sachet	3476063674552	2 m	0,020 kg	-	1	1	18,19





- Inclusief toebehoren :**
- Transportkoffer
 - Stelling ondersteuning
 - Plooibare poten

- Accessoires inclus :**
- Coffre de transport
 - Support échafaudage
 - Pieds pliables

Snijlengte Longueur de coupe	max. 1320 mm
Snijdiepte Profondeur de coupe	max. 330 mm
Hoeksneede Coupe à angle	0° → 90°
Schuine snede Coupe biseauté	90° → 15°
Temp. snijdraad Temp. fil chaud	350°
Transformator Transformateur	40V / 200W / 230V
IP-klasse Classification IP	IP 44

RECHTHOEK RECTANGLE	SCHUIN EN ANGLE	TRAPSGEWIJS ÉTAGÉE
AFGESCHUIND CHANFREINÉE	GROEVEN RAINURAGE	

Tafelzaag met verwarmde snijdraad voor polystyreen
Table de découpe avec fil chaud pour polystyrène



ED 366855



code							min.	€
ED 266555	koffer/coffre	3476060026651	H max. 1320 mm D/P max. 330 mm	19,000 kg	-	1	1	944,00
ED 366855	zakje/sachet	3476060036681	1500 mm	0,110 kg	-	1	1	12,88

Vervangsnijdraad • Fil chaud de rechange

Snijdiepte Profondeur de coupe	max. 500 mm
Snijdikte Épaisseur de coupe	max. 310 mm
Hoge positie (hoogte) Position haute (hauteur)	tot/jusqu'à 1000 mm
Lage positie (hoogte) Position basse (hauteur)	tot/jusqu'à 600 mm

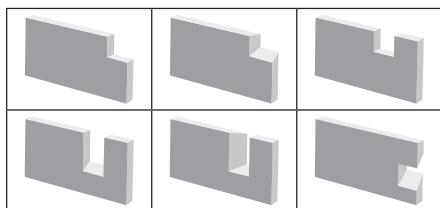

± 5 hrs*



± 70 min

* Gebruik van 20 seconden elke 4 minuten
Utilisation de 20 secondes toutes les 4 minutes



- Inclusief toebehoren :**
- Li-ion batterij + lader
 - Transportkoffer
 - 2 posities mogelijk

- Accessoires inclus :**
- Batterie Li-ion + chargeur
 - Valise de transport
 - 2 positions possibles



Hulpstuk voor snijden van hoeken voor ED 266555
Accessoire de coupe verticale pour ED 266555

code							min.	€
ED 366655	koffer/coffre	3476060036667	D/P max. 310 mm	9,135 kg	-	1	1	629,00

NEW**ISOCUT
Hybrid****MULTISystem****MULTI BATTERY Compatible**

(adapters niet inbegrepen/adaptateurs non inclus)



Lengte- en dieptebegeer.
Limiteur de longueur
et de profondeur.

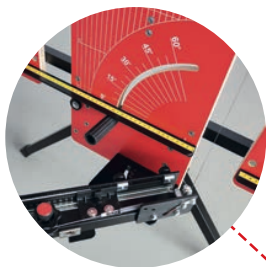

Nauwkeurige hoeksne.
Coupe d'angle précise.



Efficiënt gereedschapsloos
wisselen van de hete draad.
Changement efficace
du fil chaud sans outil.



Extra stabiliteit.
Stabilité
supplémentaire.

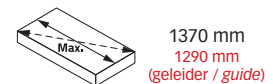

1370 mm
1290 mm
(geleider / guide)



330 mm

Afmetingen toegeplooid
Dimensions repliées
1575 x 820 mm

ISOCUT HYBRID - Isolatiesnijtafel
ISOCUT HYBRID - Table de découpe d'isolation

code							min.	€
SR 4700200	zak/sac	542000075283	H max. 1370 mm D/P max. 330 mm	20,000 kg	9	1	1	445,00

**TOEBEHOREN VOOR
ISOCUT OP BLZ. 499
ACCESSOIRES POUR
ISOCUT SUR P. 499**

Mogelijke sneden / Coupes possibles

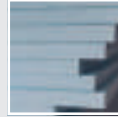
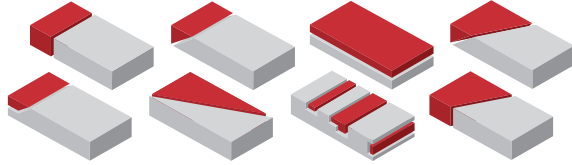

EPS
geëxpandeerd
polystyreen
polystyrène
expansé

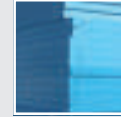

XPS
geëxtrudeerd
polystyreen
polystyrène
extrudé



NEW

**ISOCUT
Hybrid SET**



MULTISystem

MULTI BATTERY Compatible



(adapters niet inbegrepen/adaptateurs non inclus)



**ISOCUT HYBRID SET - Isolatiesnijtafel + 2x 18V batterij 4Ah +
batterijlader 2 poorten + koffer**
**ISOCUT HYBRID SET - Table de découpe d'isolation +
2x batterie 18V 4Ah + Chargeur de batterie 2 ports + coffre**

code							min.	€
SR 4700855	koffer/coffre	542000075290	H max. 1370 mm D/P max. 330 mm	34,000 kg	6	1	1	715,00

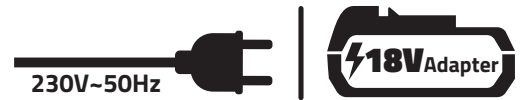
NEW**ISOCUT COMPACT
Hybrid****MULTI**System

MULTI BATTERY Compatible

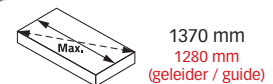
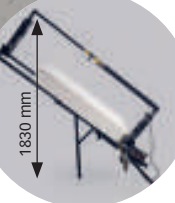

(adapters niet inbegrepen/adaptateurs non inclus)

Telescopisch inschuifbaar
voor gemakkelijker transport.
Rétractable télescopiquement
pour un transport plus facile.Biedt extra stabiliteit. Telescopisch
in hoogte verstelbaar, geschikt
voor gebruik in ruimtes met
beperkte hoogte.Offre une stabilité
supplémentaire.
Réglable en
hauteur de
manière
télescopique,
il permet une
utilisation dans
les espaces à
hauteur limitée.Afmetingen toegeplooid
Dimensions repliées
1250 x 560 mm**ISOCUT COMPACT HYBRID - Isolatiesnijtafel****ISOCUT COMPACT HYBRID - Table de découpe d'isolation**

code							min.	€	
SR 4725000	koffer/coffre	5420000075313		H max. 1370 mm D/P max. 330 mm	32,000 kg	4	1	1	890,00

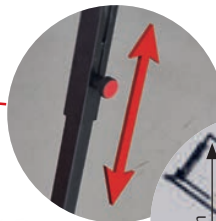
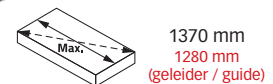
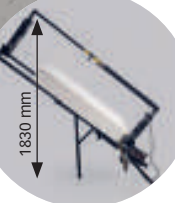
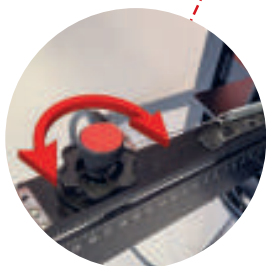
Lengte- en dieptebe grenzer.
Limiteur de longueur
et de profondeur.Nauwkeurige hoeksne de.
Coupe d'angle précise.Telescopisch inschuifbaar
voor gemakkelijker transport.
Rétractable télescopiquement
pour un transport plus facile.Biedt extra stabiliteit. Telescopisch
in hoogte verstelbaar, geschikt
voor gebruik in ruimtes met
beperkte hoogte.Offre une stabilité
supplémentaire.
Réglable en
hauteur de
manière
télescopique,
il permet une
utilisation dans
les espaces à
hauteur limitée.Afmetingen toegeplooid
Dimensions repliées
1250 x 560 mmEfficiënt gereedschapsloos
wisselen van de hete draad.
Changement efficace
du fil chaud sans outil.**TOEBEHOREN VOOR ISOCUT OP BLZ. 499
ACCESSOIRES POUR ISOCUT SUR P. 499**

Mogelijke sneden / Coupes possibles

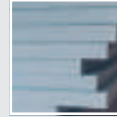
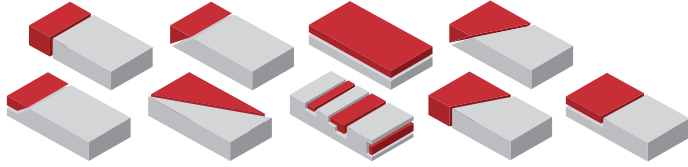

EPS
geëxpandeerd
polystyreen
polystyrène
expansé

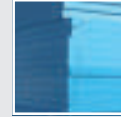

XPS
geëxtrudeerd
polystyreen
polystyrène
extrudé



ISOCUT COMPACT **NEW** Hybrid SET



MULTISystem

MULTI BATTERY Compatible



(adapters niet inbegrepen/adaptateurs non inclus)



ISOCUT COMPACT HYBRID SET - Isolatiesnijtafel + 2x 18V batterij 4Ah +
batterijlader 2 poorten + koffer

ISOCUT COMPACT HYBRID SET - Table de découpe d'isolation +
2x batterie 18V 4Ah + Chargeur de batterie 2 ports + coffre

code							min.	€
SR 4725122	koffer/coffre	5420000075320	H max. 1370 mm D/P max. 330 mm	34,000 kg	-	1	1	1029,00

ISOCUT HANDY

NEW



ISOCUT HANDY 230V - Isolatiesnijboog
ISOCUT HANDY 230V - Arche de découpe d'isolation

code							min.	€
SR 4730100		5420000075344	H max. 1360 mm D/P max. 330 mm	2,800 kg	16	1	1	155,00



SR 4730100



EPS
geëxpandeerd
polystyreen
polystyrène
expansé

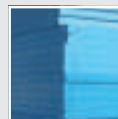

XPS
geëxtrudeerd
polystyreen
polystyrène
extrudé

Mogelijke sneden / Coupes possibles

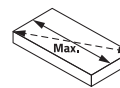

1360 mm

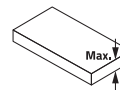

330 mm



Efficiënt gereedschapsloos
wisselen van de hete draad.
Changement efficace
du fil chaud sans outil.



Incl.



ISOCUT HANDY 18V - Isolatiesnijboog
ISOCUT HANDY 18V - Arche de découpe d'isolation

code							min.	€
------	--	--	--	--	--	--	------	---

SET : Isolatiesnijboog 18V + 2x 18V batterij 2Ah + batterijlader 2 poorten
SET : Arche de découpe d'isolation 18V + 2x batterij 18V 2Ah + Chargeur de batterie 2 ports

SR 4730122		5420000075351	H max. 1360 mm D/P max. 330 mm	2,800 kg	16	1	1	259,00
------------	--	---------------	-----------------------------------	----------	----	---	---	---------------

SR 4730122

**TOEBEHOREN VOOR / ACCESSOIRES POUR
ISOCUT HYBRID / ISOCUT COMPACT HYBRID / ISOCUT HANDY**

Verwarmde snijdraad voor ISOCUT • Fil chaud pour ISOCUT

code							min.	€
SR 4729900		5420000075337	1520 mm	0,010 kg	-	1000	1	8,60



Batterij 18V • Batterie 18V

code							min.	€
INSULCUT / ISOCUT HANDY compatibel • compatible								
SR 4750020		5420000075269	Li-ion - 2.0 Ah	0,350 kg	-	30	1	46,35
ISOCUT / ISOGUN compatibel • compatible								
SR 4750140		5420000075276	Li-ion - 4.0 Ah	0,580 kg	-	30	1	75,00



Batterijlader • Chargeur de batterie

code							min.	€
1 poort • 1 port								
SR 4750260		5420000075474	2Ah / 4Ah	0,350 kg	-	20	1	23,20
2 poorten • 2 ports								
SR 4750255		5420000075467	2Ah / 4Ah	0,600 kg	-	6	1	35,00



Batterij-adapters • Adaptateurs pour batterie

code							min.	€
SR 4750301		5420000075481	BOSCH	0,140 kg	-	25	1	20,85
SR 4750302		5420000075498	DEWALT	0,140 kg	-	25	1	20,85
SR 4750303		5420000075504	MAKITA	0,140 kg	-	25	1	20,85
SR 4750304		5420000075511	MILWAUKEE	0,140 kg	-	25	1	20,85

**Transportkoffer voor ISOCUT HYBRID
Coffre de transport pour ISOCUT HYBRID**

code							min.	€
SR 4700915		5420000075306	-	16,000 kg	6	1	1	169,00



**HARD
CASE**

ISOGUN

230V-50Hz

LUCHTKOELING
REFROIDISSEMENT PAR AIR

NEW



Temperatuurregeling
in 3 stappen.
Réglage de température
à 3 niveaux.

200
mm

250
W

MAX
500°C

ISOGUN 230V - Isolatiesnijder
ISOGUN 230V - Couteau thermique

5 standen.
5 positions.

Toebehoren incl:

- 1 blad 200 mm
- 1 metalen borstel
- 1 inbusleutel
- kunststoffen koffer

Accessoires incl:

- 1 lame 200 mm
- 1 brosse métallique
- 1 clé allen
- coffret en plastique

code							min.	€
SR 4741505	koffer/coffre	5420000075368	250 W	1,400 kg	120	10	1	120,00



EPS
geëxpandeerd
polystyreen
polystyrène
expansé



XPS
geëxtrudeerd
polystyreen
polystyrène
extrudé

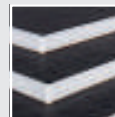

PU
polyurethaan
polyuréthane

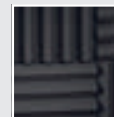

**POLYESTER
FOAM**
polyesterschuim
mousse polyester

ISOGUN 18V

NEW

18V 4.0Ah

LUCHTKOELING
REFROIDISSEMENT PAR AIR

110 min

50 min



Temperatuurregeling
in 3 stappen.
Réglage de température
à 3 niveaux.



5 standen.
5 positions.

200
mm

MAX
500°C

ISOGUN 18V - Isolatiesnijder
ISOGUN 18V - Couteau thermique

Incl.



Toebehoren incl:

- 1 Li-ion batterij 18V 4.0 Ah
- 1 batterijlader - 1 poort
- 1 blad 200 mm
- 1 metalen borstel
- 1 inbusleutel
- kunststoffen koffer

Accessoires incl:

- 1 batterie Li-ion 18V 4.0 Ah
- 1 chargeur de batterie - 1 port
- 1 lame 200 mm
- 1 brosse métallique
- 1 clé allen
- coffret en plastique

code							min.	€
SR 4742000	koffer/coffre	5420000075375	18V - 4.0 Ah	4,000 kg	56	4	1	195,00

TOEBEHOREN VOOR / ACCESSOIRES POUR
ISOGUN

Vervangblad • lame de rechange

code							min.	€
SR 4742095		5420000075382	150 mm	0,016 kg	-	50	1	12,58
SR 4742096		5420000075399	200 mm	0,025 kg	-	50	1	22,51

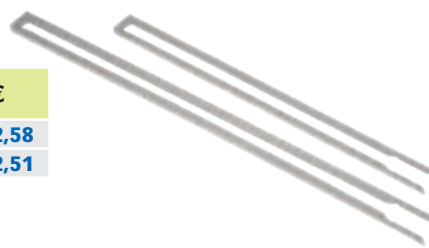

Sleuvenmakerset incl. 3 snijringen
Set d'outils à rainurer avec 3 anneaux de coupe

code							min.	€
SR 4742097		5420000075405	20 / 27 / 34 mm	0,300 kg	-	25	1	59,90

Snijgeleider • Guide de coupe

code							min.	€
SR 4742098		5420000075412	≤ 170 mm	0,380 kg	-	10	1	25,20



Perforator • Perforateur

code							min.	€
SR 4742099		5420000075429	Ø 70 mm	0,120 kg	-	50	1	34,80

Verlengstuk • Rallonge

code							min.	€
SR 4742100		5420000075436	1230 mm	0,900 kg	-	25	1	106,00



Batterij 18V • Batterie 18V

code							min.	€
SR 4750140		5420000075276	Li-ion - 4.0Ah	0,580 kg	-	30	1	75,00



Batterijlader • Chargeur de batterie

code							min.	€
SR 4750260		5420000075474	2Ah / 4Ah	0,350 kg	-	20	1	23,20

SR 4750301

SR 4750302

Batterij-adapters • Adaptateurs pour batterie



code							min.	€
SR 4750301		5420000075481	BOSCH	0,140 kg	-	25	1	20,85
SR 4750302		5420000075498	DEWALT	0,140 kg	-	25	1	20,85
SR 4750303		5420000075504	MAKITA	0,140 kg	-	25	1	20,85
SR 4750304		5420000075511	MILWAUKEE	0,140 kg	-	25	1	20,85

NEW

INSULCUT 18V

18V 2.0Ah

55 min 25 min

150 mm

300 mm

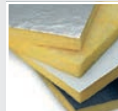

GLASS WOOL



ROCK WOOL

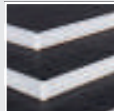

POLYURETHANE

INSULCUT 18V - Elektrische reciprozaag
INSULCUT 18V - Scie sabre électrique

code						min.	€
SR 4743250	koffer/coffre	5420000075443	18V - 2.0 Ah	4,250 kg	56	4 1	179,00

Toebehoren incl:

- 2 Li-ion batterijen 18V 2.0 Ah
- 1 batterijlader - 1 poort
- 1 zaagblad 150 mm
- 1 zaagblad 300 mm
- kunststoffen koffer

Accessoires incl:

- 2 batteries Li-ion 18V 2.0 Ah
- 1 chargeur de batterie - 1 port
- 1 lame de scie 150 mm
- 1 lame de scie 300 mm
- coffret en plastique

TOEBEHOREN VOOR / ACCESSOIRES POUR INSULCUT

Reciprozaagblad • **Lame de scie sabre**

code						min.	€
SR 4740392		5420000075450	300 mm	0,080 kg	-	1 1	16,90

Batterij 18V • **Batterie 18V**



code						min.	€
SR 4750020		5420000075269	Li-ion - 2.0 Ah	0,350 kg	-	30 1	46,35

Batterijlader • **Chargeur de batterie**



code						min.	€
1 poort • 1 port							
SR 4750260		5420000075474	2Ah / 4Ah	0,350 kg	-	20 1	23,20

SR 4750301

SR 4750302



SR 4750303

SR 4750304

Batterij-adapters • **Adaptateurs pour batterie**

code						min.	€
SR 4750301		5420000075481	BOSCH	0,140 kg	-	25 1	20,85
SR 4750302		5420000075498	DEWALT	0,140 kg	-	25 1	20,85
SR 4750303		5420000075504	MAKITA	0,140 kg	-	25 1	20,85
SR 4750304		5420000075511	MILWAUKEE	0,140 kg	-	25 1	20,85

Speciaal isolatiemes • Couteau spécial pour matériel isolant

code							min.	€
ZE 8980		5420000010383	mes / lame 140 x 19 x 0,9 mm	166 gr	40	10	1	10,05
ZE 8982		5420000010376	vervangmes / lame de rechange	40 gr	200	50	5	7,57
LK 644030		5420000030640	mes / lame - 280 mm	160 gr	60	10	1	13,17
LK 650035		5420000030657	mes / lame - 340 mm	244 gr	60	10	1	15,42
LK 650042		5420000071124	mes / lame - 420 mm	330 gr	40	10	1	16,75
LK 665300		5420000046184	mes / lame - 300 mm	270 gr	72	12	1	23,63
ED 168055		3476060016805	mes / lame - 420 mm	306 gr	-	10	1	43,45
SR 20975050		5420000057128	mes / lame - 225 mm & 300 mm	251 gr	-	12	1	33,45

Tot einde voorraad • Jusqu'à épuisement des stocks

	GLASWOL LAINE DE VERRE	PU-PANELEN PANNEAUX PU	ROTSWOL LAINE DE ROCHE	STYROPOR	SCHUIMPLASTIEK MOUSSE EN PLASTIQUE
ZE 8980	✓	✓	-	-	-
LK 650035 LK 650042	✓	-	✓	-	-
LK 644030	✓	-	✓	✓	✓
LK 665300	✓	-	✓	✓	✓
ED 168055	✓	-	✓	✓	✓
SR 20975050	✓	✓	✓	✓	✓

Handzaag isolatie PREMIUM 255H
Scie isolation PREMIUM 255H

code							min.	€
GM 255H22	vrac	7392746460501	L mm 550	430 gr	-	10	1	44,85





Mengstang type MM 2 • Mélangeur type MM 2



code			schacht tige				min.	€
		mm Ø mm	mm					
FC 070206		400 60	8	0,262 kg	72	12	1	7,85
FC 070208		400 80	8	0,313 kg	48	12	1	8,44
FC 070210		600 100	10	0,628 kg	24	6	1	12,87
FC 070212		600 120	10	0,720 kg	18	6	1	16,81



SDS-Plus Aansluiting • Raccordement SDS-Plus

FC 070300		400 80	10	0,358 kg	48	12	1	8,95
-----------	--	--------	----	----------	----	----	---	-------------

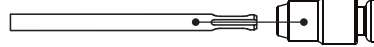

FC 070300
SDS-PLUS

Mengstang type MM 1 • Mélangeur type MM 1

code			schacht tige				min.	€
		mm Ø mm	mm					
CP 370006		350 60	6	0,096 kg	-	100	1	3,35
FC 071208		400 80	8	0,313 kg	48	12	1	9,96
Met PVC korf • Avec hélice PVC								
CP 371588	vrac	400 80	8	0,206 kg	-	30	1	8,07

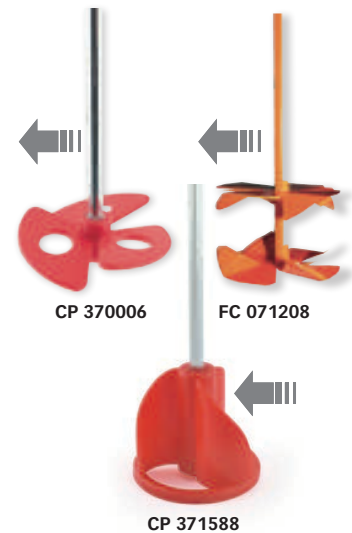

CP 370006

FC 071208

CP 371588

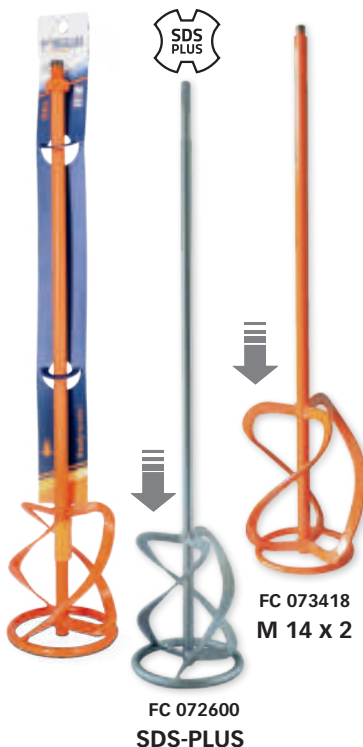

FC 073418
M 14 x 2

FC 072600
SDS-PLUS

Mengstang type MM 3 • Mélangeur type MM 3



code			schacht tige				min.	€
		mm Ø mm	mm					
FC 071612		600 120	12,2	1,026 kg	18	6	1	24,69



Aansluiting M 14 x 2 • Raccordement M 14 x 2

FC 071512		600 120	14	1,186 kg	18	6	1	25,17
FC 071615M		600 140	14	1,299 kg	12	6	1	28,04
FC 073428		650 180	18	2,227 kg	-	4	1	30,60
FC 073418		740 180	18	2,406 kg	-	4	1	30,85



SDS-Plus Aansluiting • Raccordement SDS-Plus

FC 072600		600 120	12	0,934 kg	18	6	1	14,90
-----------	--	---------	----	----------	----	---	---	--------------

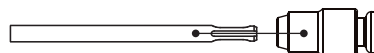

Mengstang type MM 4 • Mélangeur type MM 4



code				schacht tige					min.	€
			mm	Ø mm	mm					
FC 070408		5420000010291	500	80	8	0,381 kg	72	12	1	12,73
FC 070410		5420000010307	500	100	8	0,426 kg	48	12	1	13,07
FC 070412		5420000010314	600	120	10	0,841 kg	18	6	1	20,71

Aansluiting M 14 x 2 • Raccordement M 14 x 2

FC 070512		5420000010321	600	120	14	1,176 kg	18	6	1	22,77
FC 070514		5420000010338	600	140	14	1,318 kg	18	6	1	25,17

SDS-Plus Aansluiting • Raccordement SDS-Plus

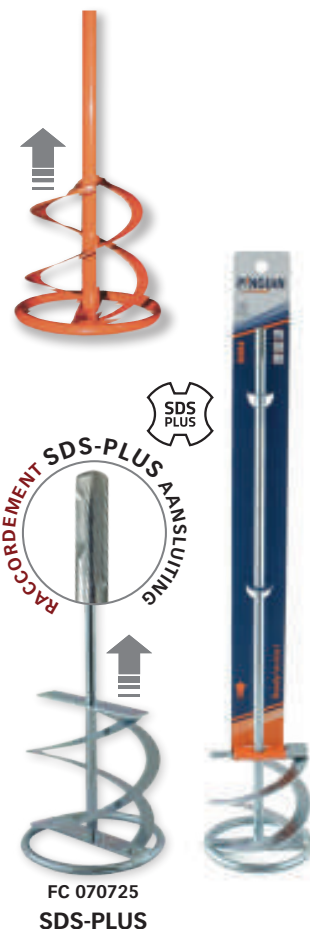
FC 070708		5420000073586	500	80	10	0,478 kg	72	12	1	12,30
FC 070725		5420000073609	600	120	12	0,636 kg	18	6	1	13,60



		● GESCHIKT / APTE		● AANBEVOLEN / RECOMMANDÉ					
		MM1	MM2	MM3	MM4	MM1	MM2	MM3	MM4
LAGE VISCOSITEIT FAIBLE VISCOSITÉ	Wandkleuren • Peintures murales	●●	●●						
	Lak / glazuur • Vernis / Glaçages	●●	●●						
	Lijm • Colle	●	●						
MIDDELHOGE VISCOSITEIT VISCOSITÉ MOYENNE	Kleefmortel • Mortier adhésif			●	●●				
	Tegellijm • Colle pour dalles				●●				
	Dichtingsmateriaal • Masses d'étanchement				●				
	Kleefstof • Adhésifs				●				
	Plamuurpasta • Mastic			●	●●				
	Voegpasta • Pâte d'étanchéité pour joints		●		●●				
	Afwerkmortel • Enduit de finitio			●	●●				
	Dunnelaagmortel • Revêtement épais				●				
	Mortel • Mortier			●	●				
	Herstellingsmortel • Mortier de préparation			●	●				
HOGE VISCOSITEIT HAUTE VISCOSITÉ	Beton • Béton				●				
	Gipspleister • Plâtre				●				
	Cementresten • Enduit de ciment			●●	●				
	Warmte-isolatieresten • Enduit d'isolation thermique			●●	●				
	Bi-component materialen • Matériaux bi-composant				●				

 Zie ook / Voir aussi **p.7 & p.8 EIBENSTOCK**



PL 284023



PL 285024

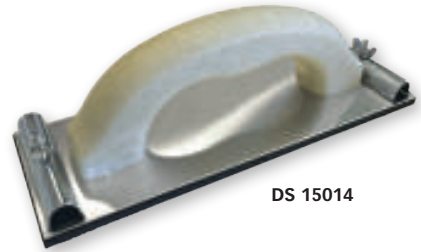

DS 15014

new design

QUICK-CLIX



PL 284500



DS 15010

Handschoorder voor schuurgas • Ponceuse à main

code								min.	€
Kunststofbasis • Monture en plastique			mm						
PL 284023	vrac	5420000018037	230 x 80	0,240 kg	-	-	40	1	5,08
PL 285024	vrac	5420000000964	235 x 105	0,274 kg	540	-	30	1	5,97
Handgreep in Softgrip + Quick-Clix • Poignée en Softgrip + Quick-Clix									
PL 284500	vrac	5420000044258	230 x 80	0,180 kg	350	-	70	1	6,93
ALU basis • Monture en alliage ALU									
DS 15014	vrac	5420000012608	235 x 85	0,266 kg	600	50	10	1	10,76
Schuurblok in rubber • Bloc de ponçage en caoutchouc									
DS 15010	vrac	5420000003521	120 x 70	0,338 kg	-	-	48	1	4,30

Schoorder met kniegewricht op steel Ponceuse à manche avec articulation

code								min.	€
DS 15045	vrac	5420000012387	240 x 85 mm	0,945 kg	150	10	2		27,80

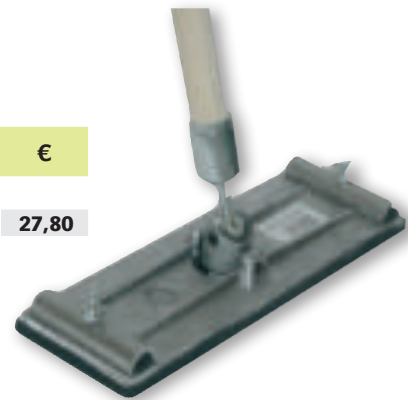

Schoorgas voor handschoorders • Grille emeri pour ponceuses à main

code									min.	€
			mm							
				voorwaarde conditionnement						
KR DC710		5420000018358	280 x 90	per 10 st./par 10 pcs	P 80	0,191 kg	-	50	1	4,11
KR DC122		5420000000025	280 x 105	per 3 st./par 3 pcs	P 100	0,055 kg	-	100	1	2,68
KR DC123		5420000000032	280 x 105	per 10 st./par 10 pcs	P 100	0,172 kg	-	100	1	4,11
KR DC120	vrac	5420000010208	280 x 105	per 50 st./par 50 pcs	P 100	0,783 kg	-	20	1	18,22
KR DC810		5420000018365	280 x 90	per 10 st./par 10 pcs	P 120	0,143 kg	-	100	1	4,11
KR DC910		5420000018372	280 x 90	per 10 st./par 10 pcs	P 220	0,134 kg	-	100	1	4,11

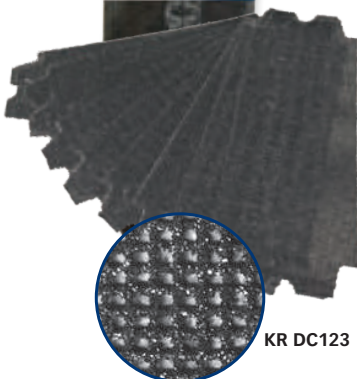

KR DC123



ED 064755



ED 164755

Blokschaaf metaal VARIO RAP • Rabot universel, rape métallique VARIO RAP

code							min.	€
ED 064755		3476060006479	257 mm	0,426 kg	-	5	1	23,43
Vervangblad • Grille de rechange								
ED 164755	vrac	3476060016478	257 mm	0,045 kg	-	1	1	10,18

Blokschaaf metaal • Rabot universel, rape métallique

code							min.	€
DS 14800		5420000003569	250 mm	0,211 kg	432	48	6	16,39
Vervangblad • Grille de rechange								
DS 14805		5420000003576	250 mm	0,040 kg	-	-	12	6,62

Blokschaaf ALU • Rabot universel, rape ALU

code							min.	€
DS 14831		5420000060517	140 mm	0,100 kg	96	12	1	9,20

Kantensnijder voor gipsplaten
Trusquin de plaquiste pour plaques de plâtre

code							min.	€
DS 15242		5420000012905	max. 120 mm	0,931 kg	-	18	1	21,88

PLAC & ROLL Kantensnijder voor gipsplaten
PLAC & ROLL Trusquin pour la découpe de bandes de plâtre

code							min.	€
ED 062955		3476060006295	max. 150 mm	0,829 kg	-	6	1	55,20



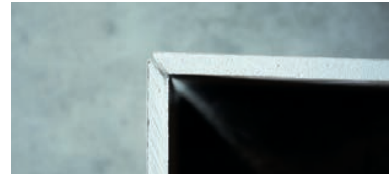
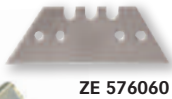

Afkantschaaf voor gipsplaten, met instelbare snijhoek "RAP-PLAC"
Rabot à chanfreiner pour plaques de plâtre, à angle variable "RAP-PLAC"

code							min.	€
ED 069255		3476060006929	22° - 45°	0,572 kg	-	-	5 1	44,85
Vervangmessen - Lames de rechange								Per 5 st • Par 5 pcs
ZE 576060		5420000062962	60 x 0,65 x 19 mm	0,030 kg	3800	200	10 10	1,48



Grote kantensnijder voor gipsplaten • Grand trusquin de plaquiste

code							min.	€
RM 502160		3479135021605	max. 600 mm	0,900 kg	-	1 1	1 1	89,10
inclusief potlood • crayon inclus								

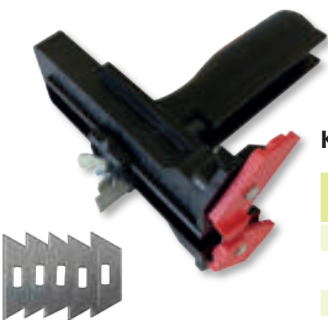

Kantensnijder voor gipsplaten • Trusquin de plaquiste

code							min.	€
RM 502650		3479135026501	max. 100 mm	0,334 kg	-	1 1	1 1	70,30
Vervangmessen • Lames de rechange								Per 5 st • Par 5 pcs
RM 502638		3479135026389	50 x 19 x 0,7 mm	0,020 kg	-	1 1	1 1	6,41

45° kantensnijder • Rabot à chanfreiner 45°

code							min.	€
RM 502618		3479135026181	302 x 160 x 80 mm	0,204 kg	-	1 1	1 1	25,83
Vervangmessen • Lames de rechange								Per 5 st • Par 5 pcs
RM 502638		3479135026389	50 x 19 x 0,7 mm	0,020 kg	-	1 1	1 1	6,41



Dispenser voor voegband (voor gordel) Dériveur de bande à joint (pour ceinture)



code			A	B	C				min.	€
ED 069855			60	250	50	0,370 kg	-	1	1	14,32

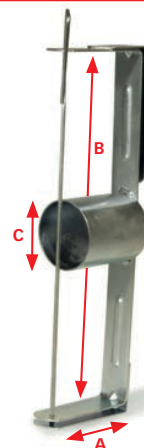

Hoekroller voor voegband Rouleur d'angle pour bande à joint



code							min.	€
Binnenhoek • Angle intérieur								
ED 278055			-	0,540 kg	-	1	1	84,00
Buitenhoek • Angle extérieur								
ED 278155			-	0,460 kg	-	1	1	84,00
Telescopische stang voor ED 278055 & ED 278155 Perche télescopique pour ED 278055 & ED 278155								
ED 169955			120 → 240 cm	0,600 kg	-	1	1	20,02



Clinch-on hoekzetter met rubber hamer Clinch-on fixateur angulaire avec marteau caoutchouc

code							min.	€
DS 15160	vrac		285 mm	1,744 kg	12	3	1	45,30



T-winkelhaak • Équerre-T

code							min.	€
KP 316	vrac		1200 mm	0,650 kg	-	1	1	19,26

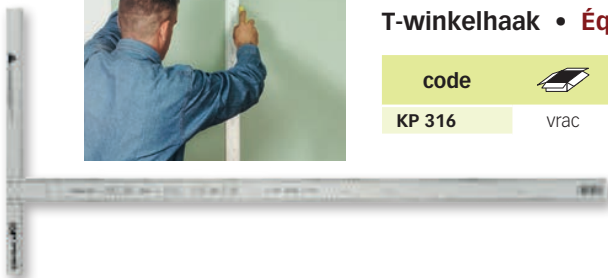

Snijregel voor gipsplaten • Règle à découper les plaques de plâtre

code							min.	€
ED 163155	vrac		max. 620 mm	0,611 kg	-	10	1	53,50



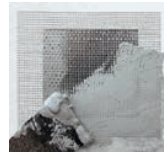
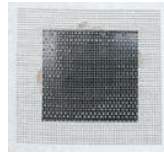
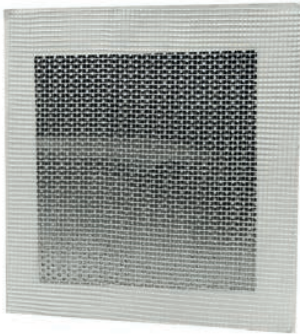

PATCH'UP Reparatie patch voor gipsplaten
PATCH'UP Patch de réparation pour plaque de plâtre

code							min.	€
ED 178055		3476061780552	150 x 150 mm	0,056 kg	-	100	1	3,58



Steekzaag, hardpoint vertanding
Scie à guichet, denture trempée hardpoint

G-MAN®

code								min.	€
GM 150H12	vrac	7392746450120	L mm	# inch/pouce	190 gr	-	10	1	15,68
			300	7					



incl. hoesje
housse incl.

Steekzaag ideaal voor gipsplaten, zeer stijf blad
Poinard pour plaque de plâtre, lame très rigide



code								min.	€
			L mm	# inch/pouce					
SOFT GRIP greep • Manche SOFT GRIP									
ED 067055		3476060006707	150	7 - 8	150 gr	-	5	1	19,34
ED 067255		3476060006721	250	7 - 8	250 gr	-	5	1	23,99
Houten greep • Manche bois									
CP 368415	vrac	4022307158167	150	7 - 8	82 gr	-	10	1	6,20

DS 31127

CP 388027



Rattestaart steekrasp • Râpe cylindrique

code							min.	€
DS 31127		5420000012806	300 mm x Ø 5,4 mm	0,084 kg	-	12	1	13,65
CP 388027	vrac	4022307121246	270 mm x Ø 5 mm	0,056 kg	-	50	1	18,36



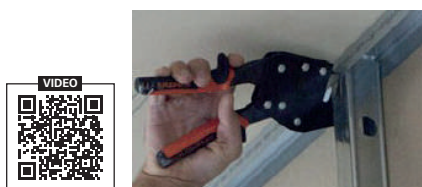

ED 062055
MASTER PROFIL



ED 060055
PROFIL

Profielverbindingstang • Pince à sertir les profilés

code							min.	€
ED 060055		3476060006004	1 + 1 mm	0,938 kg	-	5	1	59,80
ED 062055		3476060006202	1 + 1 mm	0,710 kg	-	5	1	63,20

Profielverbindingstang - ERGOTOP Pince à sertir les profilés - ERGOTOP



ED 061955
ERGOTOP

code							min.	€
ERGOTOP								
ED 061955		3476060006196	1 + 1 mm	0,763 kg	-	5	1	93,80



ED 066855
ULTRA PROFIL

Profielverbindingstang - ULTRA PROFIL Pince à sertir les profilés - ULTRA PROFIL

code							min.	€
ULTRA PROFIL								
ED 066855		3476060006684	1 + 1 mm	0,825 kg	-	5	1	103,00



ED 161455
POWER PROFIL

Automatische profieltang voor schroefmachine - POWER PROFIL Sertisseuse automatique pour visseuse - POWER PROFIL

code							min.	€
POWER PROFIL								
ED 161455		3476060016140	1 + 1 mm	1,130 kg	-	1	1	155,00
Ponsmes voor ED 161455 • Poinçon pour sertisseuse ED 161455								
ED 061855		3476060006189	-	0,007 kg	-	1	1	9,39



ED 061855



3de hand opspantang - 60 kg Étai extensible 3ième main - 60 kg



code				Pads						min.	€
			cm	mm	max 65°	max 90°					
ED 066155	vrac	3476060006615	160 → 290	200 x 60	20 kg	60 kg	2,219 kg	6	2	1	47,20
ED 067855	vrac	3476060006783	210 → 390	200 x 60	20 kg	60 kg	3,100 kg	6	2	1	64,40

ED 066155 - ED 067855

PAD
200 x 60 mm

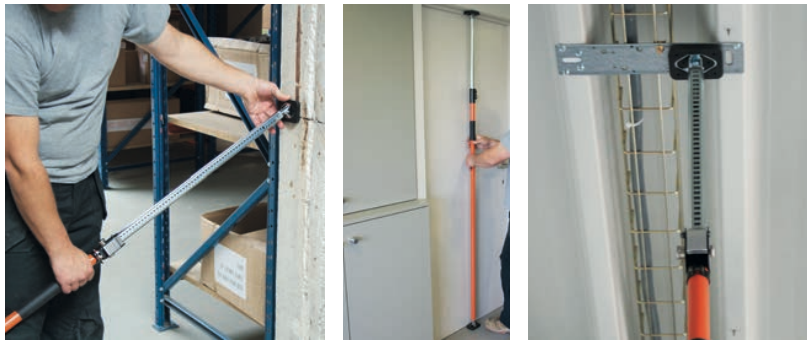

IDE 80290

PAD
80 x 60 mm

- Antislip-pads met hoge weerstand, 180° draaibaar en hogere veiligheid door de mogelijkheid om beide uiteinden te fixeren.
- Een sterk ratel-vergrendelingsysteem.
- Eindafstelling met een draadstang aan beide uiteinden.
- Patins de haute résistance, antidérapant, orientables à 180° et sécurité plus importante avec la possibilité de fixation aux deux extrémités.
- Système de blocage à crémaillère de haute résistance.
- Réglage final par une tige filetée aux deux extrémités.



IDE 80125

PAD
80 x 60 mm

3de hand opspantang Étai extensible 3ième main



code				Pads						min.	€
			cm	mm	max 65°	max 90°					
MINI • 75 → 125 cm											
IDE 80125		5420000060463	75 → 125	80 x 60	20 kg	60 kg	1,750 kg	-	10	1	35,75
STANDA(A)RD • 160 → 290 cm											
IDE 80290		5420000040694	160 → 290	80 x 60	20 kg	60 kg	2,219 kg	-	10	1	39,40





Platendragers voor gipsplaten • Poignées de transport pour plaques

code							min.	€
DUOPLAC per paar • par paire								
ED 064055		3476060006400	140 x 115 mm	1,288 kg	-	5	1	24,87
RM 502100		3479135021001	170 x 145 mm	0,686 kg	-	5	1	39,65
TRANSPLAC								
ED 064555	vrac	3476060006455	565 x 140 mm	1,211 kg	-	2	1	24,19



Voethefboom voor gipsplaten Lève plaque à pied

code							min.	€
FOOTPLAC								
ED 066055		3476060006608	305 x 140 mm	1,025 kg	10	5	1	22,85



Platenklem voor gipsplaten • Cale plaque par blocage

code							min.	€
RM 502050	vrac	3479135020509	H = 80 cm	1,321 kg	-	1	1	37,95



LEVPANO I

CENTRALE REGELBARE ARMEN
BRAS CENTRAUX REGLABLES
0,60 m - 0,90 m - 1,20 m

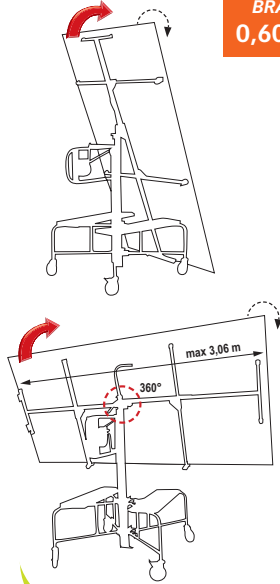

Schuin
Incliné

Horizontaal
Horizontale

ref. RM 513000

€ 1078,00

EAN : 3479135130000



Verticaal
Verticale



LEVPANO II

CENTRALE REGELBARE ARMEN
BRAS CENTRAUX REGLABLES
0,60 m - 0,90 m - 1,20 m

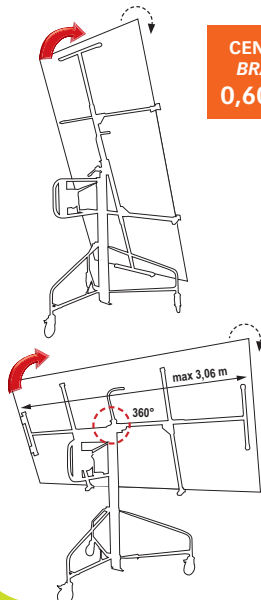







ref. RM 514000

€ 911,00

EAN : 3479135140009



Toebehoren voor LEVPANO I en LEVPANO II Accessoires pour LEVPANO I et LEVPANO II

code							min.	€
Gereedschapshouder • Support outil								
RM 513100	vrac	3479135131007	-	1,000 kg	-	1	1	54,40
Platform • Plate-forme								
RM 513200	vrac	3479135132004	495 x 505 mm	6,600 kg	-	1	1	87,50

RM 513100

RM 513200

LEVPANO COMBI 400

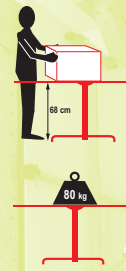
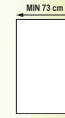
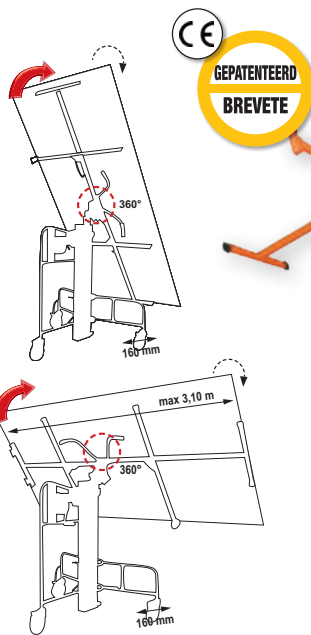

COMBI 400
ref. RM 516500
€ 1590,00

EAN : 3479135165002

COMBI 400
Verlengstuk/Rallonge 0,40 m
ref. RM 516512 inbegrepen/inclus
Voor alle afmetingen
Pour toutes mesures
600/900/1200 mm

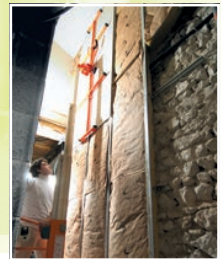

LEVPANO EASY

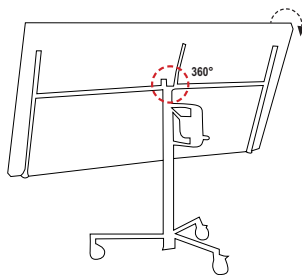



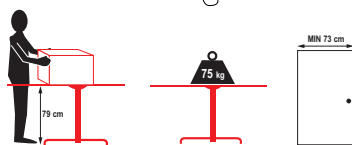



ref. RM 512850
€ 689,00
EAN : 3479130000223









	LEVPANO 01	LEVPANO 02	COMBI 400	LEVPANO EASY
Hoogte plaat horizontaal Hauteur de pose plaque horizontale	4,50 m	4,50 m	3,60 / 4,00 m	3,50 m
Laadhoogte Hauteur de chargement	0,82 m	0,82 m	0,68 m	0,79 m
Laadvermogen Charge utile	75 kg	75 kg	80 kg	75 kg
Gewicht machine Poids de l'appareil	52 kg	43 kg	53 kg	34 kg
Extra verlengstuk in optie Rallonge extra en option	-	-	0,40 m	0,50 m







**STANDARD**
 **400 kg**
**HOBBY - Houten schraag • HOBBY - Tréteau en bois**

code				 max				min.	€
PM 990417	vrac	5420000067639	B x H 73,5 cm x 74 cm	400 kg per/par set	2,100 kg	140	35	35	10,28

**PRO 50**
 **400 kg**
**SMAL MODEL
MODÈLE ÉTROIT****PRO 50 - Houten schraag • PRO 50 - Tréteau en bois**

code				 max				min.	€
PM 990423	vrac	5420000067646	B x H 53 cm x 75 cm	400 kg per/par set	2,700 kg	48	6	6	18,16

**SUPER PRO**
 **1200 kg**
**ZWAAR MODEL
MODÈLE LOURD****SUPER PRO - Houten schraag • SUPER PRO - Tréteau en bois**

code				 max				min.	€
PM 991230	vrac	5420000067653	B x H 73,5 cm x 80 cm	1200 kg per/par set	4,500 kg	40	10	10	32,95

De schragen zijn niet allemaal identiek! • Les tréteaux ne sont pas tous identiques!

Schraag in PVC • Tréteau en PVC

code								min.	€
SK SH020	vrac	8019053040361	B x H 60 cm x 80 cm	200 kg per/par set	5,380 kg	44	1	1	53,00

max

200 kg
per/par set

Prijs per paar • Prix par paire



Plooibare schraag • Tréteau pliable

code								min.	€
RM 113000	vrac	3479131130004	80 cm	150 kg	3,500 kg	-	2	2	72,20

Regelbare schraag • Tréteau réglable

code								min.	€
RM 113010	vrac	3479131130103	Min. H MAX H 80 cm 130 cm	500 kg	12,000 kg	-	1	1	230,00



ROLL PLAC Mini (2 platen) • ROLL PLAC Mini (2 plaques)



code								min.	€
ED 064655	vrac	3476060646552	85 x 35 cm	80 kg	2,680 kg	-	1	1	71,30



RM 500540

Platenkar 2 wielen • Chariot porte-plaques 2 roues

code								min.	€
RM 500540	vrac	3479135005407	60 x 21 cm	450 kg	12,250 kg	9	1	1	261,00
RM 500550	vrac	3479135005506	80 x 21 cm	900 kg	13,000 kg	12	1	1	328,00



RM 500550



Inklapbare platenkar 4 wielen • Chariot porte-plaques repliable 4 roues

code								min.	€
RM 500560	vrac	3479135005605	83 x 32 cm	900 kg	25,000 kg	3	1	1	542,00